

Introduction

Parker UHP products are designed as leak-free components for critical applications where ultra-high pure conditions are required. VacuSeal™ products, with their mating gasket and toroid design, provide a metal-to-metal seal with leak-free service from vacuum to positive pressure.

Featured Products (see page 14)

- **TorqTite™** gasket to seal damaged toroids and virtually eliminate loosening of componentry due to thermocycling and vibration.
- **High-Purity Nickel and Hastelloy C-22®** glands for extremely corrosive applications.
- **Non-Rotational Female Nut** to prevent transmission of torque during make-up and therefore minimize twist of componentry which causes stress concentration.
- **Anti-Galling Female Nut** to ensure consistent make-up without plating or lubrication.

Materials

Typical Raw Material Specifications

FITTING MATERIAL	BAR STOCK	FORGINGS	RECOMMENDED TUBING SPECIFICATIONS
Stainless Steel 316	ASTM A276, ASME SA479	ASME SA182	ASME SA213, ASTM A213, ASTM A249
Stainless Steel 316L	ASTM A276, ASME SA479	ASME SA182	ASME SA213, ASTM A213, ASTM A249
Stainless Steel 316L VAR (Vacuum Arc Remelt)	ASTM A276, ASME SA479	ASME SA182	ASTM A269, MIL T8504, MIL T8506
Stainless Steel 316L VIM/VAR (Vacuum Induction Melt/Vacuum Arc Remelt)	ASTM A276, ASME SA479	ASME SA182	ASTM A269, MIL T8504, MIL T8506

Material is marked with heat code to ensure raw material traceability.

Gaskets Typical Raw Material Specifications

MATERIAL SPECIFICATIONS	
Nickel	ASTM B162 (unplated)
Stainless Steel	ASTM A167 (Silver plated)

Hastelloy C-22® is a registered trademark of Haynes International, Inc.



Specifications

- **Pressure Ratings** are based upon tests conducted on VacuSeal™ assemblies. All ratings comply with calculations per ANSI Code for Pressure Piping B31.3. **Working Pressures** are rated at ambient temperature and are based on a 4 to 1 design factor. To determine pressure ratings in accordance with ANSI B31.1, multiply **Working Pressure** by 0.94.
- **Temperature Ratings**
Fittings:
Stainless Steel 316, 316L, 316L VAR, 316L VIM/VAR
1000°F (537°C)
Gaskets:
High-Purity Nickel
600°F (315°C)
Silver plated Stainless Steel
1000°F (537°C)
- **Dimensions** are for reference only and are subject to change. Tube ends conform to the dimensional requirements of ASTM A269.
- **Plating:** VacuSeal™ Female Nuts are Silver plated with an enhanced plating process. Avoid aggressive chemical processes used for cleaning, electropolishing and passivation that will remove plating. Removal or damage to plating will cause threads to gall, damaging fitting components and preventing a proper seal.
- **Testing:** VacuSeal™ products are rated to a Helium leak rate of 1×10^{-9} STD cc/sec.
- **Internal Surface Finishes:** VacuSeal™ components are available with controlled surface finishes and electropolished internal surfaces.
- **Cleaning and Packaging:** Ultra-High Purity 'OMEGA' cleaning and packaging in a Class 100 Clean Room environment validated per Federal Standard 209E, is standard for all electropolished VacuSeal™ components.

For Make-Up Instructions see page 15.

For Ordering Instructions see page 17.

Offer of Sale

The items described in this document are hereby offered for sale by Parker Hannifin Corporation, its subsidiaries or its authorized distributors. This offer and its acceptance are governed by the provisions stated in the "Offer of Sale" located on page 18.

WARNING

FAILURE, IMPROPER SELECTION OR IMPROPER USE OF THE PRODUCTS AND/OR SYSTEMS DESCRIBED HEREIN OR RELATED ITEMS CAN CAUSE DEATH, PERSONAL INJURY AND PROPERTY DAMAGE.

This document and other information from Parker Hannifin Corporation, its subsidiaries and authorized distributors provide product and/or system options for further investigation by users having technical expertise. It is important that you analyze all aspects of your application and review the information concerning the product or system in the current product catalog. Due to the variety of operating conditions and applications for these products or systems, the user, through its own analysis and testing, is solely responsible for making the final selection of the products and systems and assuring that all performance, safety and warning requirements of the application are met.

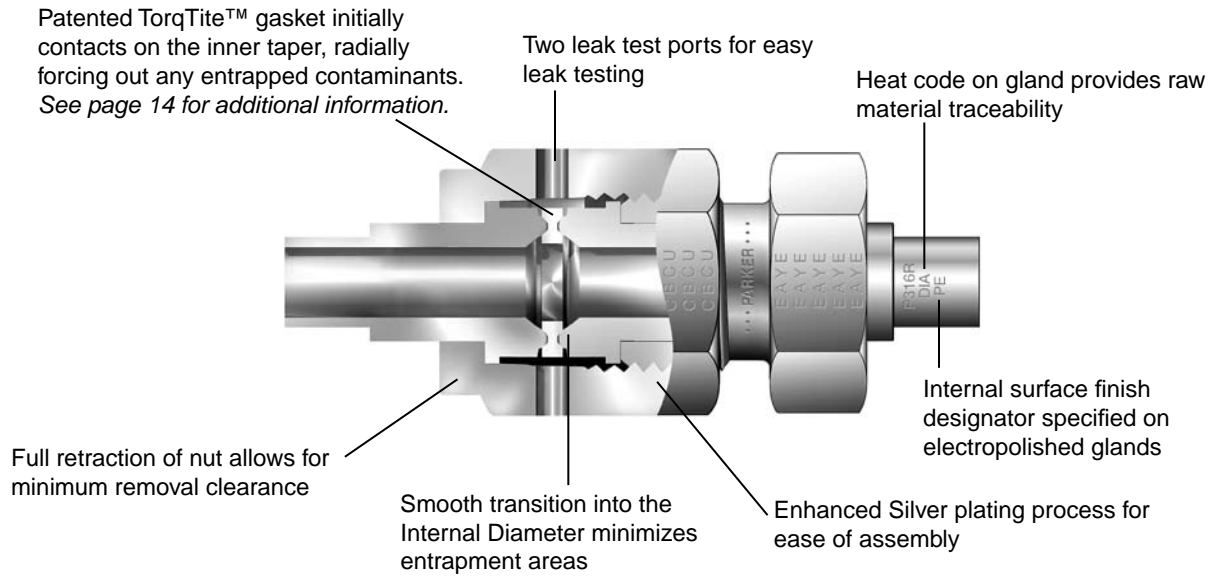

Index

Glands

Pages 4, 5, 6



Bodies

Pages 6, 7, 8, 9

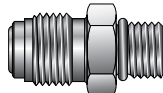

Welded Assemblies

Page 10



Welded Modules

Page 11



Gaskets

Page 12



Nuts, Caps, and Plugs

Page 13



Hi-Flo Products

Pages 14,15



Featured Products

Page 15



Make-Up Instructions

Page 16

Ordering Instructions

Page 17

Offer of Sale

Page 18

Glands

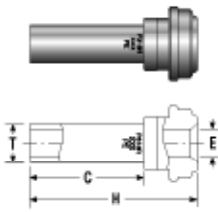

Short Tube Butt Weld

T Tube O.D.	Ordering Number	C		E		H		Normal Wall Thickness	Working Pressure	
		in.	mm	in.	mm	in.	mm		psi	bar
fractional										
1/8	2-2 V1T3-* 1.08	0.75	19.0	0.07	1.8	1.08	27.4	0.028	8500	580
1/4	^4-4 V1M-* .60	0.25	6.3	0.18	4.6	0.60	15.2	0.035	5100	350
1/4	4-4 V1TW-* .72	0.38	9.7	0.18	4.6	0.72	18.3	0.035	5100	350
1/4	4-4 V1T3-* 1.10	0.75	19.0	0.18	4.6	1.10	27.9	0.035	5100	350
1/4	8-4 V1T3-* 1.12	0.75	19.0	0.18	4.6	1.12	28.4	0.035	3500	240
3/8	8-6 V1M-* .62	0.25	6.3	0.31	7.9	0.62	15.7	0.035	3300	220
3/8	8-6 V1T3-* 1.12	0.75	19.0	0.31	7.9	1.12	28.4	0.035	3300	220
1/2	^^8-8 V1M-* .62	0.25	6.3	0.40	10.2	0.62	15.7	0.049	3500	240
1/2	8-8 V1TW-* .74	0.38	9.7	0.40	10.2	0.74	18.8	0.049	3500	240
1/2	8-8 V1T3-* 1.12	0.75	19.0	0.40	10.2	1.12	28.4	0.049	3500	240
metric										
6 mm	4-6M V1T3-* -1.16	0.75	19.0	0.16	4.1	1.16	29.5	1.0 mm	6800	460
8 mm	4-8M V1T3-* -1.16	0.75	19.0	0.24	6.1	1.16	29.5	1.0 mm	4900	330
10 mm	8-10M V1T3-* -1.16	0.75	19.0	0.31	7.9	1.16	29.5	1.0 mm	3500	240
12 mm	8-12M V1T3-* -1.16	0.75	19.0	0.39	9.9	1.16	29.5	1.0 mm	3100	210
18 mm	12-18M V1T3-* -1.22	0.75	19.0	0.59	15.0	1.22	31.0	1.5 mm	3000	200

^Old Part Number 4-4 V1M-* .035

^^Old Part Number 8-8 V1M-* .049

Long Tube Weld

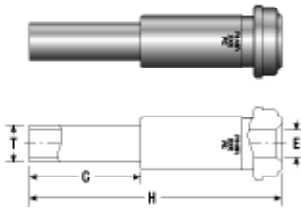

T Tube O.D.	Ordering Number	C		E		H		Normal Wall Thickness	Working Pressure	
		in.	mm	in.	mm	in.	mm		psi	bar
fractional										
1/8	2-2 V1T3-* 1.42	0.75	19.0	0.07	1.8	1.42	36.1	0.028	8500	580
1/4	4-4 V1M-* 1.20	0.25	6.3	0.18	4.6	1.20	30.5	0.035	5100	350
1/4	4-4 V1T3-*	0.40	10.2	0.18	4.6	1.31	33.3	0.035	5100	350
1/4	4-4 V1TW-* 1.32	0.38	9.7	0.18	4.6	1.32	33.5	0.035	5100	350
1/4	4-4 V1T3-* 1.70	0.75	19.0	0.18	4.6	1.70	43.2	0.035	5100	350
1/4	8-4 V1T3-* 1.79	0.75	19.0	0.18	4.6	1.80	45.7	0.035	3500	240
3/8	8-6 V1M-* 1.29	0.25	6.3	0.31	7.9	1.29	32.8	0.035	3300	220
3/8	8-6 V1T3-* 1.79	0.75	19.0	0.31	7.9	1.79	45.5	0.035	3300	220
1/2	8-8 V1M-* 1.29	0.25	6.3	0.40	10.2	1.29	32.8	0.049	3500	240
1/2	8-8 V1TW-* 1.41	0.38	9.7	0.40	10.2	1.41	35.8	0.049	3500	240
1/2	8-8 V1T3-* 1.79	0.75	19.0	0.40	10.2	1.79	45.5	0.049	3500	240
3/4	12-12 V1T3-* 2.03	0.75	19.0	0.65	16.5	2.03	51.6	0.049	2400	160
1	16-16 V1T3-* 2.32	0.75	19.0	0.87	22.1	2.32	58.9	0.065	2400	160
metric										
6 mm	4-6M V1T3-* 1.70	0.75	19.0	0.16	4.1	1.70	43.2	1.0 mm	6800	460
8 mm	4-8M V1T3-* 1.70	0.75	19.0	0.24	6.1	1.70	43.2	1.0 mm	4900	330
10 mm	8-10M V1T3-* 1.79	0.75	19.0	0.31	7.9	1.79	45.5	1.0 mm	3500	240
12 mm	8-12M V1T3-* 1.79	0.75	19.0	0.39	9.9	1.79	45.5	1.0 mm	3100	210
18 mm	12-18M V1T3-* 2.03	0.75	19.0	0.59	15.0	2.03	51.6	1.5 mm	3000	200

Short Automatic Tube Butt Weld

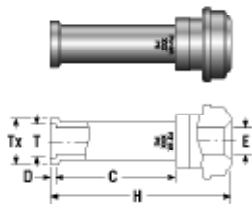

T Tube Size	Ordering Number	C		D		E		H		Tx		Normal Wall Thickness	Working Pressure	
		in.	mm	in.	mm	in.	mm	in.	mm	in.	mm		psi	bar
fractional														
1/4	4-4 V1Y3-* 1.12	0.75	19.0	0.02	0.5	0.18	4.6	1.12	28.4	0.29	7.4	0.035	5100	250
1/2	8-8 V1Y3-* 1.16	0.75	19.0	0.04	1.0	0.40	10.2	1.16	29.5	0.55	14.0	0.049	3500	240
3/8	8-6 V1Y3-* 1.15	0.75	19.0	0.03	0.8	0.30	7.6	1.15	29.2	0.41	10.4	0.035	3300	220
metric														
6 mm	4-6M V1Y3-* 1.18	0.75	19.0	0.02	0.5	0.16	4.1	1.18	30.0	0.27	6.9	1.0 mm	6800	460
8 mm	4-8M V1Y3-* 1.19	0.75	19.0	0.03	0.8	0.24	6.1	1.19	30.2	0.35	8.9	1.0 mm	4900	330
10 mm	8-10M V1Y3-* 1.22	0.75	19.0	0.03	0.8	0.31	7.9	1.22	31.0	0.43	10.9	1.0 mm	3500	240
12 mm	8-12M V1Y3-* 1.20	0.75	19.0	0.04	1.0	0.39	9.9	1.20	30.5	0.52	13.2	1.0 mm	3100	210

Glands (Continued)

Long Automatic Tube Butt Weld

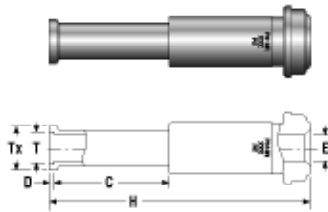

T Tube Size	Ordering Number	C		D		E		H		Tx		Normal Wall Thickness	Working Pressure	
		in.	mm	in.	mm	in.	mm	in.	mm	in.	mm		psig	bar
fractional														
1/4	4-4 V1Y3-* 1.72	0.75	19.0	0.02	0.5	0.18	4.6	1.72	43.7	0.29	7.4	0.035	5100	350
1/4	8-4 V1Y3-* 1.82	0.75	19.0	0.02	0.5	0.18	4.6	1.82	46.2	0.29	7.4	0.035	5100	350
3/8	8-6 V1Y3-* 1.82	0.75	19.0	0.03	0.8	0.31	7.9	1.82	46.2	0.41	10.4	0.035	3300	220
1/2	8-8 V1Y3-* 1.83	0.75	19.0	0.04	1.0	0.40	10.2	1.83	46.5	0.55	14.0	0.049	3500	240
3/4	12-12 V1Y3-* 2.07	0.75	19.0	0.04	1.0	0.65	16.5	2.07	52.6	0.80	20.3	0.049	2400	160
1	16-16 V1Y3-* 2.57	0.96	24.4	0.04	1.0	0.87	22.1	2.57	65.3	1.06	26.9	0.065	2400	160
metric														
6 mm	4-6M V1Y3-* 1.72	0.75	19.0	0.02	0.5	0.16	4.1	1.72	43.7	0.27	6.9	1.0 mm	6800	460
12 mm	8-12M V1Y3-* 1.83	0.75	19.0	0.04	1.0	0.39	9.9	1.83	46.5	0.52	13.2	1.0 mm	3100	210
18 mm	12-18M V1Y3-* 2.07	0.75	19.0	0.04	1.0	0.59	15.0	2.07	52.6	0.76	19.3	1.5 mm	3000	200

Short Socket Weld



T Tube Socket	Ordering Number	D		E		H		Tx		Working Pressure	
		in.	mm	in.	mm	in.	mm	in.	mm	psig	bar
fractional											
1/4	4-4 V1W-* .50	0.28	7.1	0.19	4.8	0.50	12.7	0.35	8.9	5500	370
1/4	4-4 V1W-* .75	0.28	7.1	0.19	4.8	0.75	19.0	0.35	8.9	5500	370

Socket Weld



T Tube Socket	Ordering Number	D		E		H		Tx		Working Pressure	
		in.	mm	in.	mm	in.	mm	in.	mm	psig	bar
fractional											
1/16	1-1 V1W-* ①	0.10	2.5	0.05	1.3	0.70	17.8	0.13	3.3	9000	620
1/8	2-2 V1W-* .70	0.10	2.5	0.09	2.3	0.70	17.8	0.20	5.1	7100	480
1/4	4-4 V1W-*	0.28	7.1	0.19	4.6	1.31	33.3	0.35	8.9	5500	370
3/8	8-6 V1W-*	0.31	7.9	0.28	7.1	1.50	38.1	0.60	15.2	3500	240
1/2	8-8 V1W-*	0.38	9.7	0.40	10.2	1.50	38.1	0.60	15.2	3000	200
3/4	12-12 V1W-*	0.44	11.2	0.62	15.7	2.00	50.8	0.88	22.4	2800	190
1	16-16 V1W-*	0.62	15.7	0.87	22.1	2.22	56.4	1.19	30.2	2400	160

Reducing Socket Weld

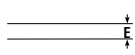

T Tube Socket	Ordering Number	D		E		H		Tx		Working Pressure	
		in.	mm	in.	mm	in.	mm	in.	mm	psig	bar
fractional											
1/8	4-2 V1W-* 1.31	0.16	4.1	0.09 ②	2.3	1.31	33.3	0.35	8.9	8000	550
1/4	8-4 V1W-*	0.25	6.3	0.19	4.8	1.50	38.1	0.60	15.2	3500	240

Blind (undrilled) Gland

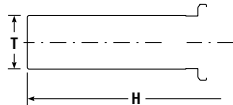

Ordering Number	H	
	in.	mm
2-2 V1W-* -BL	0.70	17.8
4-4 V1W-* -BL	1.31	33.3
8-8 V1W-* -BL	1.50	38.1
12-12 V1W-* -BL	2.00	50.8
16-16 V1W-* -BL	2.22	56.4

- ① Uses 2 BV-SS and 2 BVI-SS nuts
- ② May contain internal transitions
- ③ O-rings fluorocarbon is standard. Contact local Parker representative for other available materials

Glands (Continued)

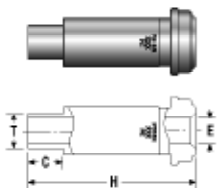

Male Weld

T Tube O.D.	Ordering Number	C		E		H		Working Pressure		
		in.	mm	in.	mm	in.	mm	psig	bar	
fractional										
1/8	2-2 V1T3-* .70 .035	0.28	7.1	0.06	2	1.5	0.70	17.8	9000	620
1/8	4-2 V1T3-* 1.31 .035	0.28	7.1	0.06	2	1.5	1.31	33.3	8000	550
1/4	4-4 V1T3-* 1.31 .065	0.41	10.4	0.12	3.0	1.31	33.3	8000	550	
1/4	8-4 V1T3-* D970351	0.41	10.4	0.12	3.0	1.50	38.1	3500	240	
3/8	8-6 V1T3-* 1.50 .049	0.41	10.4	0.28	7.1	1.50	38.1	3500	240	
1/2	8-8 V1T3-*	0.50	12.7	0.40	10.2	1.50	38.1	3500	240	
3/4	12-12 V1T3-* 2.00 .109	0.62	15.7	0.53	13.5	2.00	50.8	3000	200	
1	16-16 V1T3-* 2.22 .120	0.81	20.6	0.75	19.0	2.22	56.4	2400	160	

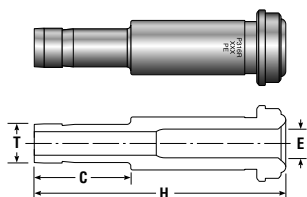

Tube Adapter (A-LOK®)

T Tube O.D.	Ordering Number	C		E		H		Working Pressure		
		in.	mm	in.	mm	in.	mm	psig	bar	
fractional										
1/4	4-4 V1TU-*	0.62	15.7	0.16	4.1	1.62	41.1	8000	550	
3/8	8-6 V1TU-*	0.69	17.5	0.28	2	7.1	1.81	46.0	3500	240
1/2	8-8 V1TU-*	0.91	23.1	0.39	9.9	1.78	45.2	3500	240	

Replace 'U' with a '2' to designate groove for CPI™ Fitting.

Bodies

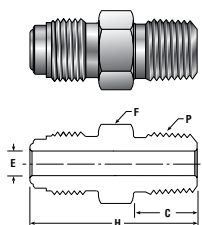

Male NPT Connector

P Male NPT Size	Ordering Number	C		E		F Hex Flat	H		Working Pressure	
		in.	mm	in.	mm		in.	mm	psig	bar
fractional										
1/16	2-1 FV-SS	0.38	9.6	0.09	2	2.3	3/8	1.07	27.2	9000 620
1/8	2-2 FV-SS	0.38	9.6	0.09	2	2.3	7/16	1.07	27.2	9000 620
1/8	4-2 FV-SS	0.38	9.6	0.19	4.8	5/8	1.28	32.5	8000	550
1/4	4-4 FV-SS	0.57	14.5	0.25	.64	5/8	1.49	37.8	8000	550
3/8	8-6 FV-SS	0.57	14.5	0.38	9.6	15/16	1.62	41.1	3500	240
1/2	8-8 FV-SS	0.76	19.3	0.41	10.4	15/16	1.81	46.0	3500	240
3/4	12-12 FV-SS	0.76	19.3	0.62	15.7	1 15/16	2.19	55.6	3000	200
1	16-16 FV-SS	0.95	24.1	0.87	22.1	1 15/16	2.47	62.7	2400	160

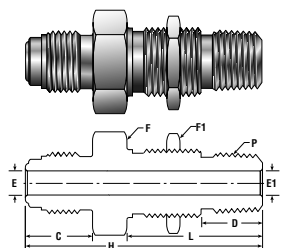

Male Bulkhead Connector

P Male NPT Size	Ordering Number	C		D		E		E1		F Hex Flat	F1 Hex Flat	H		L		Panel Hole Size	Max. Panel Thick- ness	Working Pressure	
		in.	mm	in.	mm	in.	mm	in.	mm			in.	mm	in.	mm			psig	bar
fractional																			
1/4	4-4 VH2BF-SS	0.62	15.7	0.57	14.5	0.25	6.4	0.25	6.4	13/16	13/16	2.21	56.134	1.24	31.5	21/32	0.38	8000	550
1/4	8-4 VH2BF-SS	0.75	19.1	0.57	14.5	0.41	10.4	0.28	7.1	15/16	13/16	2.34	59.436	1.24	31.5	21/32	0.38	3500	240

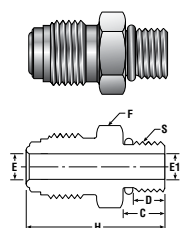

Straight Thread O-Ring Seal Male Connector 3

S Straight Thread Size	Ordering Number	C		D		E		E1		F Hex Flat	H		Uniform O-Ring Size	Working Pressure	
		in.	mm	in.	mm	in.	mm	in.	mm		psig	bar			
fractional															
9/16-18	4-6 VHOA-SS	0.39	9.9	0.25	6.4	0.18	4.6	0.28	7.1	3/4	1.33	33.78	Fluorocarbon 906	4500	310
7/8-14	8-10 VHOA-SS	0.50	12.7	0.4	10.2	0.28	7.1	0.59	15.0	1	1.66	42.16	Fluorocarbon 910	3500	240
9/16-18	8-6 VHOA-SS	0.39	9.9	0.39	9.9	0.28	7.1	0.28	7.1	15/16	1.48	7.59	Fluorocarbon 906	3500	240

Bodies (Continued)

Female NPT Connector

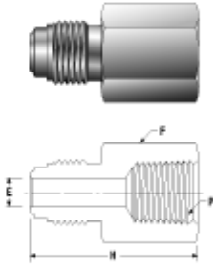

P Female NPT Size	Ordering Number	E		F Hex Flat	H		Working Pressure	
		in.	mm		in.	mm	psig	bar
fractional								
1/16	2-1 GV-SS	0.09	2.3	7/16	1.1	27.9	6700	460
1/8	2-2 GV-SS	0.09	2.3	9/16	1.19	30.2	6500	440
1/8	4-2 GV-SS	0.18	4.6	5/8	1.41	35.8	8000	550
1/4	4-4 GV-SS	0.25	6.4	3/4	1.44	36.6	6600	450
3/8	8-6 GV-SS	0.41	10.4	15/16	1.62	41.1	3500	240
1/2	8-8 GV-SS	0.41	10.4	1 1/16	1.91	48.5	3500	240
3/4	12-12 GV-SS	0.62	15.7	1 5/16	2.36	59.9	3000	200
1	16-16 GV-SS	0.87	22.1	1 5/8	2.51	63.8	2400	160

Compression Tube Fitting Connector (A-LOK®)

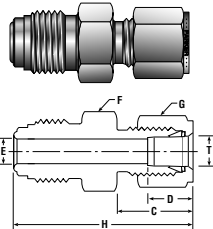

T Tube O.D.	Ordering Number	C		D		E		F Hex Flat	G Hex Flat	H		Working Pressure	
		in.	mm	in.	mm	in.	mm			in.	mm	psig	bar
fractional													
1/8	2-2 VHLZ-SS	0.60	15.2	0.50	12.7	0.09	2.3	5/8	7/16	1.53	38.86	8000	550
1/4	4-4 VHLZ-SS	0.70	17.8	0.60	15.2	0.19	4.8	5/8	9/16	1.62	41.15	8000	550
3/8	8-6 VHLZ-SS	0.76	19.3	0.66	16.8	0.28	7.1	15/16	11/16	1.84	46.74	3500	240
1/2	8-8 VHLZ-SS	0.87	22.1	0.90	22.9	0.41	10.4	15/16	7/8	1.95	49.53	3500	240

Dimensions - C, D, H are typical finger-tight.
Change "L" to a "B" to select CPI™ one ferrule connector.

For maximum pressure ratings reference the Instrument
Tubing Selection Guide, found in the Technical Section of
your Parker Instrumentation Master Binder.

Compression Tube Fitting Bulkhead Connector (A-LOK®)

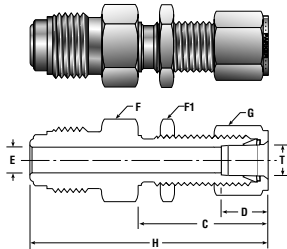

T Tube O.D.	Ordering Number	C		D		E		F Hex Flat	F1 Hex Flat	G Hex Flat	H		Panel Hole Size	Max. Panel Thick- ness	Working Pressure	
		in.	mm	in.	mm	in.	mm				in.	mm			psig	bar
fractional																
1/4	4-4 VH2LZ-SS	1.32	33.5	0.60	15.2	0.18	4.6	5/8	5/8	9/16	2.25	57.2	15/32	0.40	8000	550
1/4	4-4 VH2LZ-SS 1.88	1.05	26.7	0.60	15.2	0.18	4.6	5/8	5/8	9/16	1.88	47.8	15/32	0.13	8000	550
3/8	8-6 VH2LZ-SS	1.45	36.8	0.66	16.8	0.28	7.1	15/16	3/4	11/16	2.54	64.5	19/32	0.44	3500	240
1/2	8-8 VH2LZ-SS	1.65	41.9	0.90	22.9	0.41	10.4	15/16	15/16	7/8	2.74	69.6	25/32	0.50	3500	240

Dimensions - C, D, H are typical finger-tight.
Change "L" to a "B" to select CPI™ one ferrule connector.

For maximum pressure ratings reference the Instrument
Tubing Selection Guide, found in the Technical Section of
your Parker Instrumentation Master Binder.

Double Male Union

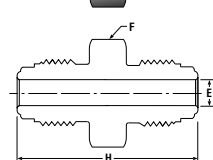

Size	Ordering Number	E		F Hex Flat	H		Working Pressure	
		in.	mm		in.	mm	psig	bar
1/8	2-2 HV-SS	0.09	2.3	3/8	1.13	28.7	9000	620
1/4	4-4 HV-SS	0.25	6.4	5/8	1.53	38.9	8000	550
1/2	8-8 HV-SS	0.41	10.4	15/16	1.84	46.7	3500	240
3/4	12-12 HV-SS	0.62	15.7	1 5/16	2.44	62.0	3000	200
1	16-16 HV-SS	0.87	22.1	1 5/8	2.59	65.8	2400	160

Double Male Reducing Union

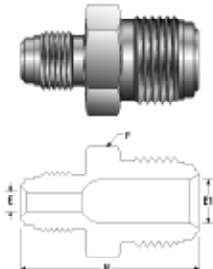

Size	Ordering Number	E		E1		F Hex Flat	H		Working Pressure	
		in.	mm	in.	mm		in.	mm	psig	bar
1/4x1/8	4-2 HV-SS	0.09	2.3	0.18	4.6	5/8	1.37	34.8	8000	550
1/2x1/4	8-4 HV-SS	0.18	4.6	0.41	10.4	15/16	1.71	43.4	3500	240

Bulkhead Union

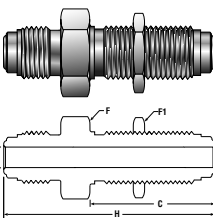

Size	Ordering Number	C		E		F Hex Flat	F1 Hex Flat	H		Panel Hole Size	Max. Panel Thick- ness	Working Pressure	
		in.	mm	in.	mm			in.	mm			psig	bar
1/4	4-4 WBV-SS 2.23	1.30	33.0	0.25	6.4	3/4	3/4	2.23	56.6	19/32	0.44	8000	550
1/4	4-4 WBV-SS 1.82	0.99	25.1	0.25	6.4	3/4	3/4	1.82	46.2	19/32	0.13	8000	550
1/2	8-8 WBV-SS 2.57	1.45	36.8	0.41	10.4	1 1/16	1 1/16	2.57	65.3	29/32	0.50	3500	240
1/2	8-8 WBV-SS 2.14	1.11	28.2	0.41	10.4	1 1/16	1 1/16	2.14	54.4	29/32	0.13	3500	240

Bodies (Continued)

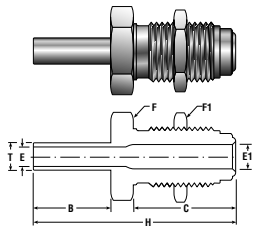

Tube Butt Weld Bulkhead Connector

T Tube O.D. Size	Ordering Number	B		C		E		E1		F Hex Flat	F1 Hex Flat	H		Panel Hole Size	Max. Panel Thick- ness	Working Pressure	
		in.	mm	in.	mm	in.	mm	in.	mm			psig	bar				
<i>fractional</i>																	
1/4	4-4 T3H2BV-* 2.36	0.75	19.1	1.30	33.0	0.18	4.6	0.22	5.6	3/4	3/4	2.36	59.9	19/32	0.44	5100	350
1/4	4-4 T3H2BV-* 1.95	0.75	19.1	0.99	25.1	0.18	4.6	0.22	5.6	3/4	3/4	1.95	49.5	19/32	0.13	5100	350

Coupling

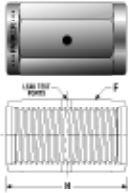

Size	Ordering Number	F Hex Flat	H	
			in.	mm
1/8	2 VHC-SS	7/16	0.66	16.8
1/4	4 VHC-SS	3/4	1.19	30.2
1/2	8 VHC-SS	1 1/16	1.31	33.3
3/4	12 VHC-SS	1 1/2	1.68	42.7
1	16 VHC-SS	1 3/4	2.04	51.8

Double Female Reducing Union

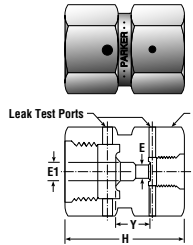

Size	Ordering Number	E		E1		F Hex Flat	H		Y		Working Pressure	
		in.	mm	in.	mm		in.	mm	in.	mm	psig	bar
1/4x1/8	4-2 HV7-SS	0.13	3.3	.25	6.4	3/4	1.16	29.5	0.36	9.1	8000	550
1/2x1/4	8-4 HV7-SS	0.25	6.4	.41	10.3	1 1/16	1.41	35.8	0.35	8.9	3500	240

Reducing Adapter

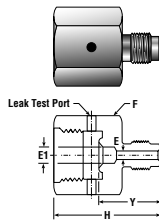

Size	Ordering Number	E		E1		F Hex Flat	H		Y		Working Pressure	
		in.	mm	in.	mm		in.	mm	in.	mm	psig	bar
1/8x1/4	4-2 V7HV-SS	0.09	2.3	.25	6.4	3/4	1.19	30.2	0.69	17.5	8000	550
1/4x1/2	8-4 V7HV-SS	0.18	4.6	.41	10.3	1 1/16	1.41	35.8	0.85	21.6	3500	240

Reducing Bushing

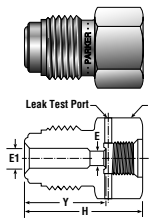

Size	Ordering Number	E		E1		F Hex Flat	H		Y		Working Pressure	
		in.	mm	in.	mm		in.	mm	in.	mm	psig	bar
1/4x1/8	4-2 VHV7-SS	0.13	3.3	.18	4.6	5/8	1.06	26.9	0.76	19.3	8000	550
1/2x1/4	8-4 VHV7-SS	0.25	6.4	.41	10.3	15/16	1.41	35.8	0.91	23.1	3500	240

VacuSeal™ To Male NPT Elbow

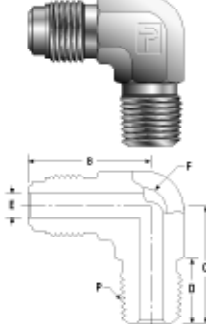

P Male NPT Size	Ordering Number	B		C		D		E		F Hex Flat	Working Pressure	
		in.	mm	in.	mm	in.	mm	in.	mm		psig	bar
1/8	2-2 CV-SS	1.07	27.2	0.87	22.1	0.38	9.6	0.18	4.6	9/16	8000	550
1/4	4-4 CV-SS	1.13	28.7	1.06	26.9	0.57	14.5	0.25	6.4	9/16	8000	550
3/8	8-6 CV-SS	1.45	36.8	1.26	32.0	0.57	14.5	0.40	10.2	7/8	3500	240
1/2	8-8 CV-SS	1.31	33.3	1.31	33.3	0.76	19.3	0.41	10.4	7/8	3500	240

Bodies (Continued)

Union Elbow

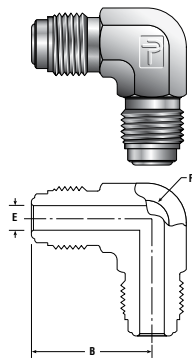

Size	Ordering Number	B		E		F Wrench Flat	Working Pressure	
		in.	mm	in.	mm		psig	bar
1/8	2-2 EV-SS	0.89	22.6	0.09	2.3	7/16	9000	620
1/4	4-4 EV-SS	1.13	28.7	0.25	6.4	9/16	8000	550
1/2	8-8 EV-SS	1.31	33.3	0.41	10.4	7/8	3500	240
3/4	12-12 EV-SS	1.92	48.8	0.62	15.7	1 1/4	3000	200
1	16-16 EV-SS	2.00	50.8	0.87	22.1	1 5/8	2400	160

Union Tee

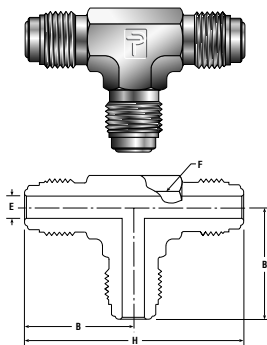

Size	Ordering Number	B		E		H		F Wrench Flat	Working Pressure	
		in.	mm	in.	mm	in.	mm		psig	bar
1/8	2-2-2 JV-SS	0.89	22.6	0.09	2.3	1.78	45.21	7/16	9000	620
1/4	4-4-4 JV-SS	1.13	28.7	0.25	6.4	2.25	57.15	9/16	8000	550
1/2	8-8-8 JV-SS	1.31	33.3	0.41	10.4	2.62	66.55	7/8	3500	240
3/4	12-12-12 JV-SS	1.92	48.8	0.62	15.7	3.84	97.54	1 1/4	3000	200
1	16-16-16 JV-SS	2.00	50.8	0.87	22.1	4.00	101.6	1 5/8	2400	160

Union Cross

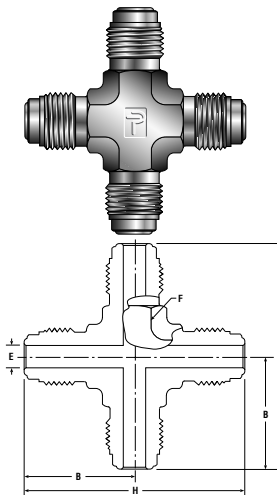

Size	Ordering Number	B		E		H		F Wrench Flat	Working Pressure	
		in.	mm	in.	mm	in.	mm		psig	bar
1/8	2 KV-SS	0.89	22.6	0.09	2.3	1.78	45.21	7/16	9000	620
1/4	4 KV-SS	1.13	28.7	0.25	6.4	2.25	57.15	9/16	8000	550
1/2	8 KV-SS	1.45	36.8	0.41	10.4	2.90	73.66	7/8	3500	240
3/4	12 KV-SS	1.92	48.8	0.62	15.7	3.84	97.54	1 1/4	3000	200
1	16 KV-SS	2.00	50.8	0.87	22.1	4.00	101.6	1 5/8	2400	160

Welded Assemblies

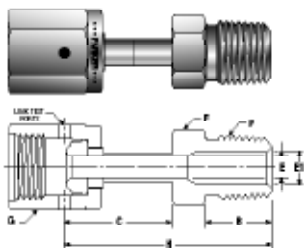

	C		E		E1		F Hex Flat	G Hex Flat	H		Working Pressure		
	mm	in.	mm	in.	mm	in.			mm	in.	mm	psig	bar
	9.6	0.95	24.1	0.18	4.6	0.19	4.8	7/16	3/4	1.58	40.1	8000	550
	14.5	0.93	23.6	0.18	4.6	0.28	7.1	9/16	3/4	1.79	45.5	5100	350
	14.5	1.00	25.4	0.40	10.2	0.41	10.3	1 1/16	1 1/16	1.89	48.0	3500	240
	19.3	1.01	25.6	0.40	10.2	0.53	13.5	7/8	1 1/16	2.09	53.1	3500	240

Female NPT Connector

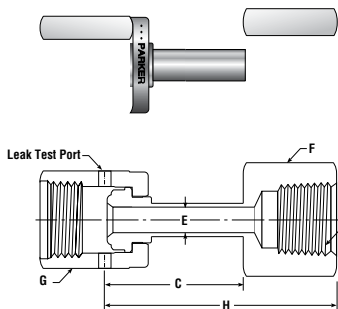

P Female NPT Size	Ordering Number	C		E		F Hex Flat	G Hex Flat	H		Working Pressure	
		in.	mm	in.	mm			in.	mm	psig	bar
fractional											
1/4	4-4 V1HBG-*	1.05	26.7	0.18	4.6	3/4	3/4	1.77	45.0	5100	350
3/8	8-6 V1HBG-*	1.06	26.9	0.40	10.2	7/8	1 1/16	1.95	49.5	3500	240
1/2	8-8 V1HBG-*	1.04	26.4	0.40	10.2	1 1/16	1 1/16	2.18	55.4	3500	240

Compression Tube Fitting Connector (A-LOK)

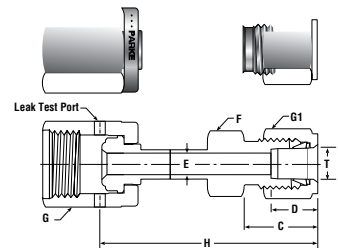

T Tube O.D.	Ordering Number	C		D		E		F Hex Flat	G Hex Flat	G1 Hex Flat	H		Working Pressure	
		in.	mm	in.	mm	in.	mm				in.	mm	psig	bar
fractional														
1/4	4-4 V1HLZ-*	0.70	17.8	0.60	15.2	0.18	4.6	1/2	3/4	9/16	1.94	49.3	5100	350
3/8	4-6 V1HLZ-*	0.76	19.3	0.67	17.0	0.18	4.6	5/8	3/4	11/16	1.97	50.0	5100	350
1/2	8-8 V1HLZ-*	0.87	22.1	0.90	22.9	0.40	10.2	13/16	1 1/16	1 7/8	2.23	56.6	3500	240

Dimensions - C, D, H are typical finger-tight.
Change "L" to a "B" to select CPI™ one ferrule connector.

For maximum pressure ratings reference the Instrument Tubing Selection Guide, found in the Technical Section of your Parker Instrumentation Master Binder.

Rotating Female Union

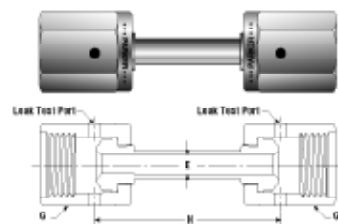

Size	Ordering Number	E		G Hex Flat	H		Working Pressure	
		in.	mm		in.	mm	psig	bar
1/4	4-4 V1HBV1-*	.18	4.6	3/4	1.35	34.3	5100	350
1/4	4-4 V1HBV1-*.170	.18	4.6	3/4	1.70	43.2	5100	350
1/2	8-8 V1HBV1-*	.40	10.2	1 1/16	1.25	31.8	3500	240
1/2	8-8 V1HBV1-*.184	.40	10.2	1 1/16	1.84	46.7	3500	240

Female Elbow

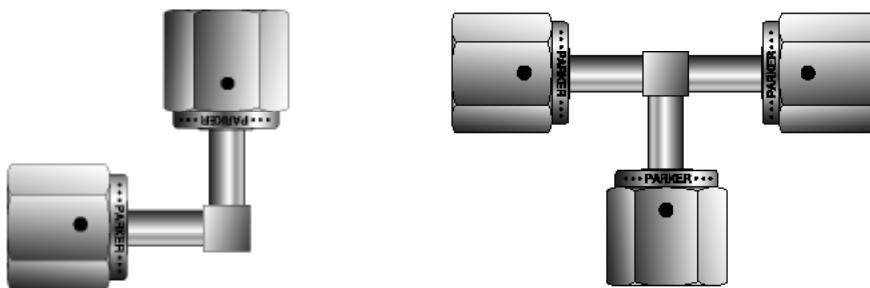

Ordering Number:
MEM-44-*.VFVF

Gaskets

VacuSeal™ gaskets are compatible with other high quality gasket face seal fittings.

Non-Retained Flat Style

Size	Ordering Number	E		H		Tx	
		in.	mm	in.	mm	in.	mm
1/8	2 VG-*	0.09	2.3	0.02	0.5	0.26	6.6
1/4	4 VG-*	0.22	5.5	0.03	0.8	0.47	11.9
1/2	8 VG-*	0.44	11.1	0.03	0.8	0.78	19.9
3/4	12 VG-*	0.66	16.8	0.03	0.8	1.14	28.9
1	16 VG-*	0.89	22.7	0.03	0.8	1.41	35.7

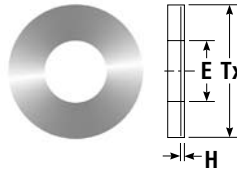

Retained Flat Style

Retainer and gasket must be used as an assembly.

Note: Nickel Retained Flat Style Gaskets utilize a Stainless Steel Retainer

Size	Ordering Number	E		H		Tx	
		in.	mm	in.	mm	in.	mm
1/4	4 VGR-*	0.23	5.8	0.03	0.8	0.50	12.7
1/2	8 VGR-*	0.44	11.2	0.03	0.8	0.79	20.1
3/4	12 VGR-*	0.66	16.8	0.03	0.7	1.14	29.0
1	16 VGR-*	0.89	22.6	0.03	0.7	1.40	35.6

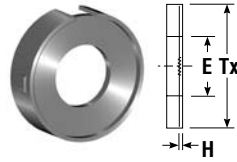

Non-Retained Grooved Style (TorqTite™ Gasket)

Size	Ordering Number	E		H		Tx		T	
		in.	mm	in.	mm	in.	mm	in.	mm
1/4	4 GVG-*	0.21	5.3	0.06	1.6	0.50	12.6	0.03	0.8
1/2	8 GVG-*	0.43	10.9	0.06	1.6	0.78	19.8	0.03	0.8

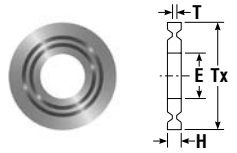

Retained Grooved Style (Retained TorqTite™ Gasket)

Size	Ordering Number	E		H		Tx		T	
		in.	mm	in.	mm	in.	mm	in.	mm
1/4	4 GVGR-*	0.21	1.3	0.06	1.6	0.49	12.4	0.03	0.8
1/2	8 GVGR-*	0.43	2.7	0.06	1.6	0.79	20.1	0.03	0.8

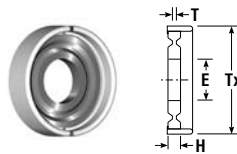

The retainer of Parker's patented Retained Flat Gasket helps to both locate the gasket over the toroid of the gland and hold the gasket in place during assembly, therefore minimizing radial damage to the toroids of the connection.

The unique design of the retainer minimizes potential scratches or nicks to the critical toroid surfaces during placement onto the gland.

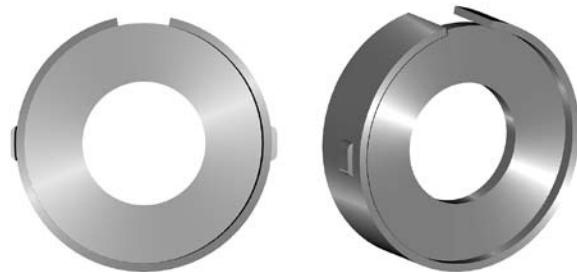

Gasket Ordering Information

Specify gasket material by replacing asterisk with appropriate Ordering Number Designator.

MATERIAL	ORDERING NUMBER DESIGNATOR	EXAMPLE
High-Purity Nickel (electropolished)	N	4 VGR-N
Stainless Steel3	SS	4 VGR-SS
Kel-F®12	K	4 VG-K
Teflon®12	T	4 VG-T

Blind (undrilled) gaskets are available by adding a -BL suffix at the end of the part number.

Example: 4 VG-N-BL

- 1 Parker uses Kel-F 81® or equal PCTFE Polymer
Parker uses Teflon® or equal PTFE Polymer
- 2 Kel-F 81® and Teflon® are only available for Non-Retained Flat Style gaskets
- 3 Stainless Steel gaskets are Silver plated

Kel-F 81® is a registered trademark of 3M Company
Teflon® is a registered trademark of Dupont Company

Note: All gaskets must be ordered in increments of 10

Nuts, Caps, and Plugs

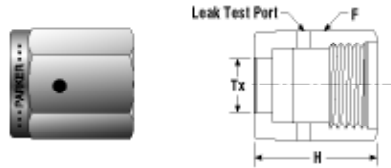

Female Nut

Ordering Number	Size	F Hex Flat	H		Tx	
			in.	mm	in.	mm
2 BV-SS	1/8	7/16	0.53	13.5	0.21	5.3
4 BV-SS-D	1/4	3/4	0.82	20.8	0.36	9.1
8 BV-SS	1/2	1 1/16	0.88	22.4	0.61	15.5
12 BV-SS	3/4	1 1/2	1.12	28.4	0.89	22.6
16 BV-SS	1	1 3/4	1.34	34.0	1.20	30.5

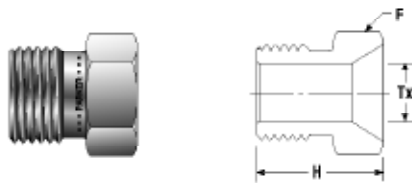

Male Nut

Ordering Number	Size	F Hex Flat	H		Tx	
			in.	mm	in.	mm
2-BVI-SS	1/8	3/8	0.50	12.7	0.21	5.3
4 BVI-SS ⁴	1/4	5/8	0.72	18.3	0.36	9.1
8-BVI-SS	1/2	15/16	0.81	20.6	0.61	15.5
12-BVI-SS	3/4	1 5/16	1.00	25.4	0.89	22.6
16-BVI-SS	1	1 5/8	1.19	30.2	1.20	30.5



Short Male Nut

Ordering Number	Size	F Hex Flat	H		Tx	
			in.	mm	in.	mm
4 BVI .54-SS	1/4	5/8	0.54	13.7	0.36	9.1
4 BVI .65-SS	1/4	5/8	0.65	16.5	0.36	9.1

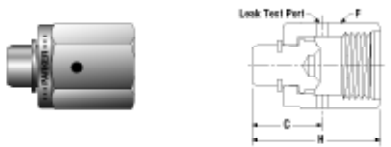

Cap

Ordering Number	Size	C		F Hex Flat	H	
		in.	mm		in.	mm
4 FNV-SS	1/4	0.59	15.0	3/4	1.00	25.4
8 FNV-SS	1/2	0.59	15.0	1 1/16	1.07	27.2
12 FNV-SS	3/4	0.66	16.8	1 1/2	1.31	33.3
16 FNV-SS	1	0.63	16.0	1 3/4	1.53	38.9

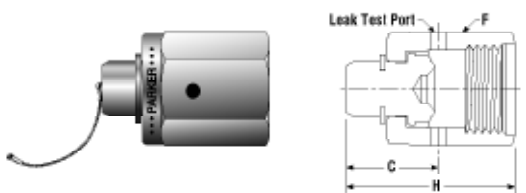

Cap With Lanyard

Ordering Number	Size	C		F Hex Flat	H		Lanyard Length	
		in.	mm		in.	mm	in.	mm
4 FNV-SS-L	1/4	0.59	15.0	3/4	1.00	25.4	6	152.4
8 FNV-SS-L	1/2	0.59	15.0	1 1/16	1.07	27.2	6	152.4

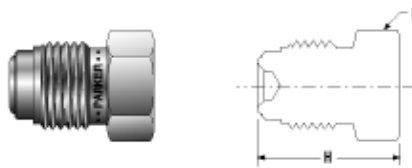

Plug

Ordering Number	Size	F Hex Flat	H	
			in.	mm
2 PNV-SS	1/8	3/8	0.68	17.3
4 PNV-SS	1/4	5/8	0.91	23.1
8 PNV-SS	1/2	15/16	1.08	27.4
12 PNV-SS	3/4	1 5/16	1.43	36.3
16 PNV-SS	1	1 5/8	1.52	38.6

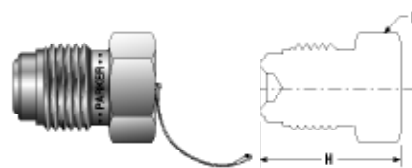

Plug With Lanyard

Ordering Number	Size	F Hex Flat	H		Lanyard Length	
			in.	mm	in.	mm
4 PNV-SS-L	1/4	5/8	0.91	23.1	6	152.4
8 PNV-SS-L	1/2	15/16	1.08	27.4	6	152.4

Protective Shipping Cap

Ordering Number	Size
C-VacuSeal	1/4

⁴ Taper in the back of nut allows mobility around 90° bends

Hi-Flo Products

Glands

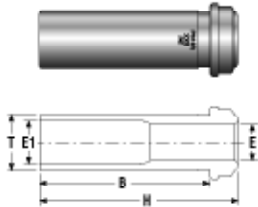

Tube Butt Weld

T Tube O.D.	Ordering Number	B		E		E1		H		Working Pressure	
		in.	mm	in.	mm	in.	mm	in.	mm	psig	bar
fractional											
3/8	4-6 VH1T3-*.60	0.41	10.4	0.25	6.4	0.30	7.6	0.60	15.2	3300	220
3/8	4-6 VH1T3-*	1.00	25.4	0.25	6.4	0.30	7.6	1.19	30.2	3300	220
3/8	4-6 VH1T3-* 1.31	1.12	28.4	0.25	6.4	0.30	7.6	1.31	33.3	3300	220

Bodies

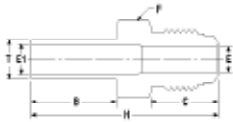

Tube Butt Weld

T Tube O.D.	Ordering Number	B		C		E		E1		F Hex Flat	H		Working Pressure	
		in.	mm	in.	mm	in.	mm	in.	mm	in.	mm	psig	bar	
fractional														
3/8	4-6 VHT3-*1.68	0.75	19.1	0.62	15.7	0.25	6.4	0.30	7.6	5/8	1.68	42.7	3300	220



Automatic Tube Weld

T Tube O.D.	Ordering Number	B		C		D		E		E1		F Hex Flat	H		Tx	Working Pressure		
		in.	mm	in.	mm	in.	mm	in.	mm	in.	mm	in.	mm	in.	mm	psig	bar	
fractional																		
3/8	4-6 VHY3-* 1.71	0.75	19.1	0.62	15.7	0.03	0.8	0.25	6.4	0.30	7.6	5/8	1.71	43.4	0.41	10.4	3300	220

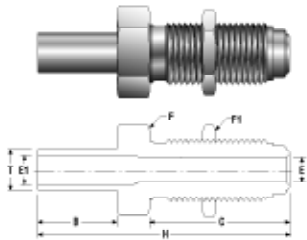

Bulkhead Connector

T Tube O.D.	Ordering Number	B		C		E		E1		F Hex Flat	F1 Hex Flat	H		Panel Hole Size	Max. Panel Thick- ness	Working Pressure	
		in.	mm	in.	mm	in.	mm	in.	mm	in.	mm	in.	mm	in.	mm	psig	bar
fractional																	
3/8	6-4 T3H2BV-* 2.36	0.75	19.1	1.30	33.0	0.23	5.8	0.30	7.6	3/4	3/4	2.36	60	19/32	0.44	3300	220

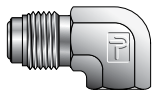

Union Elbow

Size	Ordering Number	B		E		F Wrench Flat	Working Pressure	
		in.	mm	in.	mm		psig	bar
3/8	4-4 EV-SS	1.13	28.7	0.25	6.4	0.56	8000	550

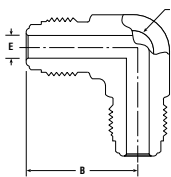

Union Tee

Size	Ordering Number	B		E		H		F Wrench Flat	Working Pressure	
		in.	mm	in.	mm	in.	mm		psig	bar
3/8	4-4-4 JV-SS	1.13	28.7	0.25	6.4	2.25	57.2	1/2	8000	550

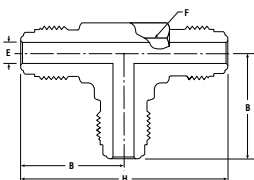

Nuts

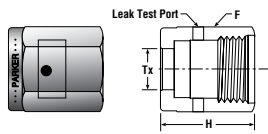

Female Nut

Size	Ordering Number	F Hex Flat	H		Tx	
			in.	mm	in.	mm
3/8	4 BVH-SS	3/4	0.82	20.8	0.39	9.9

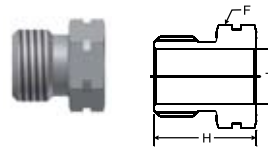

Male Nut

Size	Ordering Number	F Hex Flat	H		Tx	
			in.	mm	in.	mm
3/8	4 BVHI-SS	5/8	0.72	18.3	0.39	9.9

Featured Products

TorqTite™

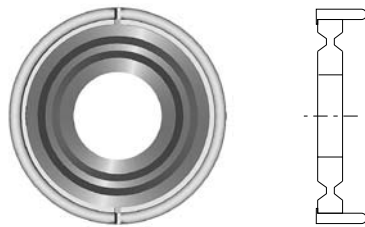

Check out the patented TorqTite™ Self-Aligning Face Seal Gasket

- Needs no installation tools
- Virtually eliminates loosening of components due to thermocycling and vibration (i.e. transportation)
- Seals even on damaged toroids
- Allows for higher torque without damaging sealing surfaces
- Easy open clean room bag requires no cutting
- Color coded retainers for material recognition
- Minimizes particle generation

*Non-Rotational Female Nut

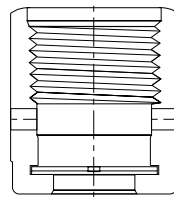

Ordering Number: 4 BV-SS-NR

Use Parker's Non-Rotational Female Nut to prevent transmission of torque during make-up and therefore minimize twist of componentry which causes stress concentration.

Anti-Galling Female Nut

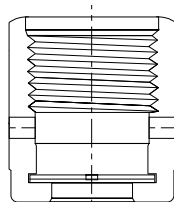
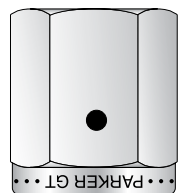

Ordering Number: 4 BV-GT

Use Parker's Anti-Galling Female Nut to ensure consistent makes and remakes without plating or lubrication on Female threads.

* Patented

Note: Outside dimensions of the Non-Rotational Female Nut and Anti-Galling Female Nut match the 4-BV-SS-D on Page 12.

Make-Up Instructions

Flat and Grooved Gasket Assembly

Step 1

Remove gasket from packaging.

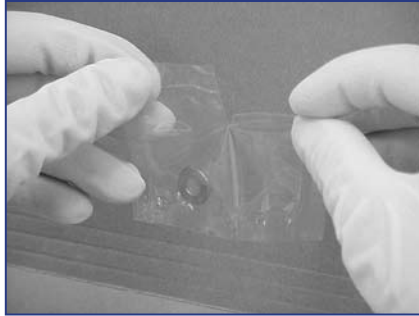

Step 2

Place gasket into female VacuSeal™ nut.

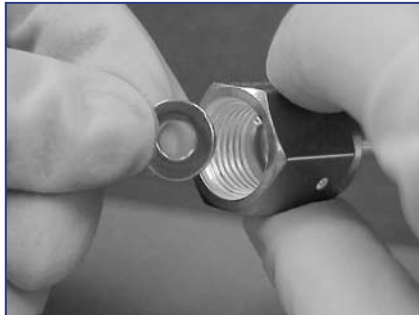

Step 3

Assemble components and snug to fingertight.

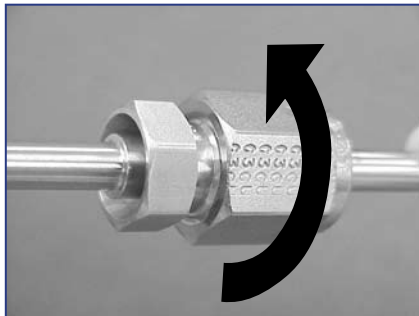

Step 4

Scribe the hex flat of both the male and female nuts.

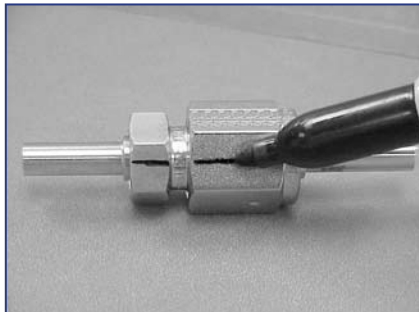

Step 5

Holding the backup wrench stationary, tighten the female nut 1/8 turn past fingertight.

Warning: Extreme over tightening will damage toroid surface and cause potential leakage.

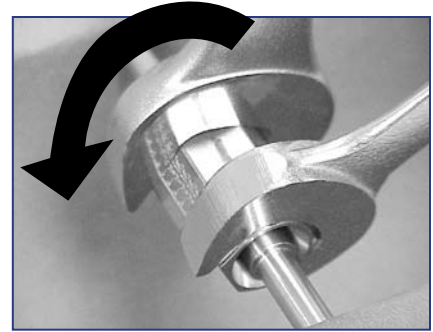

Flat Gasket Remake

Upon remake of flat VacuSeal™ gasket, a new gasket must be installed for each remake, follow procedures for initial make-up.



Retained Gaskets Assembly

Guide retained gaskets over gland face, then continue step 3 of Flat and Grooved Gasket Assembly for completion of make-up.

Protective Shipping Cap

Metallic protector caps are available to protect critical toroid surface from damage see page 12.



Ordering Instructions

How To Order

Parker VacuSeal™ components are ordered by Ordering Number, as listed in this catalog. Replace the asterisk within each Ordering Number with the corresponding material designator listed below.

Assembly Example:

If your system requires a VacuSeal™ assembly connecting from 1/4" O.D. tubing to 1/4" O.D. tubing, you may order the following parts.



Note: Each component must be ordered separately.

Nomenclature

Part numbers of Parker VacuSeal™ components are constructed from symbols that identify the size, configuration and material of each component.

Component Example:

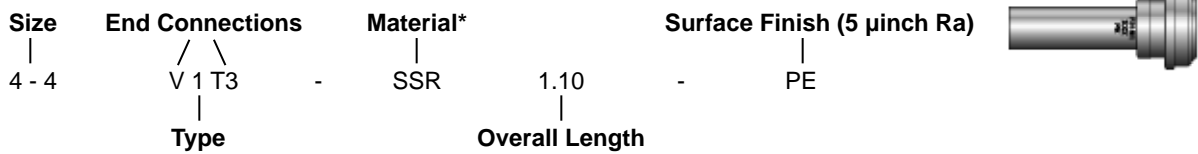

Size: Tube and Pipe are designated by the number of sixteenths of an inch. (i.e. 1/4" Pipe Thread = 4/16" = 4)
Metric Tube O.D. is designated in millimeters with the suffix "M".
(i.e. 4-6M V1T3-SSR 1.16)

Type: Designate shape of component.
(i.e. 1=gland, E=elbow, J=tee, K=cross, etc.)

***Material:** Replace asterisks in Part Number to specify material:
SS = Stainless Steel 316 (All non-welded bodies and components)
SSR = Stainless Steel 316L VAR
SSV = Stainless Steel 316L VIM/VAR
Nickel and Hastelloy C-22® available upon request.
Forged product will be offered as a 15 RA EP or a standard.

Size: End Connections: Specify VacuSeal™ end first, followed by other corresponding ends:
V = VacuSeal™
M = Butt weld with .25" tube stub length
T3 = Butt weld with .75" tube stub length
TW = Butt weld with various tube stub length
Y3 = Butt weld with End Collar
W = Socket Weld

Overall Length: Specify length of component in inches.

Note: Contact Parker representative for information on additional materials.

VacuSeal End Data Information

Size	VacuSeal Thread	*L in.	**C in.	H Hex in.	E Dia. in.
4	9/16-18	.62	.97	5/8	.19
6	7/8-14	.75	1.10	15/16	.28
8	7/8-14	.75	1.10	15/16	.41
12	1-1/4-18	1.00	1.40	1-5/16	.53

*Average Value

**Dimension C is shown in the finger tight position

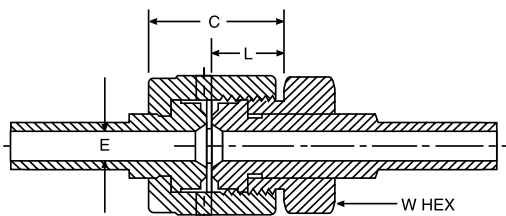

Additional Products



Parker offers a full line of MiniButtweld™ products to complement the VacuSeal™ product line. Please refer to Catalog 4280-MiniButtweld™ and Catalog 4245-UltraSeal™ Fittings for additional information.

The items described in this document and other documents or descriptions provided by Parker Hannifin Corporation, its subsidiaries and its authorized distributors are hereby offered for sale at prices to be established by Parker Hannifin Corporation, its subsidiaries and its authorized distributors. This offer and its acceptance by any customer ("Buyer") shall be governed by all of the following Terms and Conditions. Buyer's order for any such items, when communicated to Parker Hannifin Corporation, its subsidiary or an authorized distributor ("Seller") verbally or in writing, shall constitute acceptance of this offer.

1. Terms and Conditions of Sale: All descriptions, quotations, proposals, offers, acknowledgments, acceptances and sales of Seller's products are subject to and shall be governed exclusively by the terms and conditions stated herein. Buyer's acceptance of any offer to sell is limited to these terms and conditions. Any terms or conditions in addition to, or inconsistent with those stated herein, proposed by Buyer in any acceptance of an offer by Seller, are hereby objected to. No such additional, different or inconsistent terms and conditions shall become part of the contract between Buyer and Seller unless expressly accepted in writing by Seller. Seller's acceptance of any offer to purchase by Buyer is expressly conditional upon Buyer's assent to all the terms and conditions stated herein, including any terms in addition to, or inconsistent with those contained in Buyer's offer. Acceptance of Seller's products shall in all events constitute such assent.

2. Payment: Payment shall be made by Buyer net 30 days from the date of delivery of the items purchased hereunder. Amounts not timely paid shall bear interest at the maximum rate permitted by law for each month or portion thereof that the Buyer is late in making payment. Any claims by Buyer for omissions or shortages in a shipment shall be waived unless Seller receives notice thereof within 30 days after Buyer's receipt of the shipment.

3. Delivery: Unless otherwise provided on the face hereof, delivery shall be made F.O.B. Seller's plant. Regardless of the method of delivery, however, risk of loss shall pass to Buyer upon Seller's delivery to a carrier. Any delivery dates shown are approximate only and Seller shall have no liability for any delays in delivery.

4. Warranty: Seller warrants that items sold hereunder shall be free from defects in material or workmanship. **THIS WARRANTY COMPRISES THE SOLE AND ENTIRE WARRANTY PERTAINING TO ITEMS PROVIDED HEREUNDER. SELLER MAKES NO OTHER WARRANTY, GUARANTEE, OR REPRESENTATION OF ANY KIND WHATSOEVER. ALL OTHER WARRANTIES, INCLUDING BUT NOT LIMITED TO, MERCHANTABILITY AND FITNESS FOR PURPOSE, WHETHER EXPRESS, IMPLIED, OR ARISING BY OPERATION OF LAW, TRADE USAGE, OR COURSE OF DEALING ARE HEREBY DISCLAIMED.**

NOTWITHSTANDING THE FOREGOING, THERE ARE NO WARRANTIES WHATSOEVER ON ITEMS BUILT OR ACQUIRED WHOLLY OR PARTIALLY, TO BUYER'S DESIGNS OR SPECIFICATIONS.

5. Limitation of Remedy: SELLER'S LIABILITY ARISING FROM OR IN ANY WAY CONNECTED WITH THE ITEMS SOLD OR THIS CONTRACT SHALL BE LIMITED EXCLUSIVELY TO REPAIR OR REPLACEMENT OF THE ITEMS SOLD, AT SELLER'S SOLE OPTION. IN NO EVENT SHALL SELLER BE LIABLE FOR ANY INCIDENTAL, CONSEQUENTIAL OR SPECIAL DAMAGES OF ANY KIND OR NATURE WHATSOEVER, INCLUDING BUT NOT LIMITED TO LOST PROFITS ARISING FROM OR IN ANY WAY CONNECTED WITH THIS AGREEMENT OR ITEMS SOLD HEREUNDER, WHETHER ALLEGED TO ARISE FROM BREACH OF CONTRACT, EXPRESS OR IMPLIED WARRANTY, OR IN TORT, INCLUDING WITHOUT LIMITATION, NEGLIGENCE, FAILURE TO WARN OR STRICT LIABILITY.

6. Changes, Reschedules and Cancellations: Buyer may request to modify the designs or specifications for the items sold hereunder as well as the quantities and delivery dates thereof, or may request to cancel all or part of this order, however, no such requested modification or cancellation shall become part of the contract between Buyer and Seller unless accepted by Seller in a written amendment to this Agreement. Acceptance of any such requested modification or cancellation shall be at Seller's discretion, and shall be upon such terms and conditions as Seller may require.

7. Special Tooling: A tooling charge may be imposed for any special tooling, including without limitation, dies, fixtures, molds and patterns, acquired to manufacture items sold pursuant to this contract. Such special tooling shall be and remain Seller's property notwithstanding payment of any charges by Buyer. In no event will Buyer acquire any interest in apparatus belonging to Seller which is utilized in the manufacture of the items sold hereunder, even if such apparatus has been specially converted or adapted for such manufacture and not withstanding any charges paid by Buyer. Unless otherwise agreed, Seller shall have the right to alter, discard or otherwise dispose of any special tooling or other property in its sole discretion at any time.

8. Buyer's Property: Any designs, tools, patterns, materials, drawings, confidential information or equipment furnished by Buyer or any other items which become Buyer's property, may be considered obsolete and may be destroyed by Seller after two (2) consecutive years have elapsed without Buyer placing an order for the items which are manufactured using such property, Seller shall not be responsible for any loss or damage to such property while it is in Seller's possession or control.

9. Taxes: Unless otherwise indicated on the face hereof, all prices and charges are exclusive of excise, sales, use, property, occupational or like taxes which may be imposed by any taxing authority upon the manufacture, sale or delivery of the items sold hereunder. If any such taxes must be paid by Seller or if Seller is liable for the collection of such tax, the amount thereof shall be in addition to the amounts for the items sold. Buyer agrees to pay all such taxes or to reimburse Seller therefore upon receipt of its invoice. If Buyer claims exemption from any sales, use or other tax imposed by any taxing authority, Buyer shall save Seller harmless from and against any such tax, together with any interest or penalties thereon which may be assessed if the items are held to be taxable.

10. Indemnity For Infringement of Intellectual Property Rights: Seller shall have no liability for infringement of any patents, trademarks, copyrights, trade dress, trade secrets or similar rights except as provided in this Part 10. Seller will defend and indemnify Buyer against allegations of infringement of U.S. Patents, U.S. Trademarks, copyrights, trade dress and trade secrets (hereinafter 'Intellectual Property Rights'). Seller will defend at its expense and will pay the cost of any settlement or damages awarded in an action brought against Buyer based on an allegation that an item sold pursuant to this contract infringes the Intellectual Property Rights of a third party. Seller's obligation to defend and indemnify Buyer is contingent on Buyer notifying Seller within ten (10) days after Buyer becomes aware of such allegations of infringement, and Seller having sole control over the defense of any allegations or actions including all negotiations for settlement or compromise. If an item sold hereunder is subject to a claim that it infringes the Intellectual Property Rights of a third party, Seller may, at its sole expense and option, procure for Buyer the right to continue using said item, replace or modify said item so as to make it noninfringing, or offer to accept return of said item and return the purchase price less a reasonable allowance for depreciation. Notwithstanding the foregoing, Seller shall have no liability for claims of infringement based on information provided by Buyer, or directed to items delivered hereunder for which the designs are specified in whole or part by Buyer, or infringements resulting from the modification, combination or use in a system of any item sold hereunder. The foregoing provisions of this Part 10 shall constitute Seller's sole and exclusive liability and Buyer's sole and exclusive remedy for infringement of Intellectual Property Rights.

If a claim is based on information provided by Buyer or if the design for an item delivered hereunder is specified in whole or in part by Buyer, Buyer shall defend and indemnify Seller for all costs, expenses or judgments resulting from any claim that such item infringes any patent, trademark, copyright, trade dress, trade secret or any similar right.

11. Force Majeure: Seller does not assume the risk of and shall not be liable for delay or failure to perform any of Seller's obligations by reason of circumstances beyond the reasonable control of Seller (hereinafter 'Events of Force Majeure'). Events of Force Majeure shall include without limitation, accidents, acts of God, strikes or labor disputes, acts, laws, rules or regulations of any government or government agency, fires, floods, delays or failures in delivery of carriers or suppliers, shortages of materials and any other cause beyond Seller's control.

12. Entire Agreement/Governing Law: The terms and conditions set forth herein, together with any amendments, modifications and any different terms or conditions expressly accepted by Seller in writing, shall constitute the entire Agreement concerning the items sold, and there are no oral or other representations or agreements which pertain thereto. This Agreement shall be governed in all respects by the law of the State of Ohio. No actions arising out of the sale of the items sold hereunder or this Agreement may be brought by either party more than two (2) years after the cause of action accrues.

11/98-P



Parker Hannifin Corporation
6035 Parkland Blvd.
Cleveland, Ohio 44124-4141
Telephone: (216) 896-3000
Fax: (216) 896-4000
www.parker.com

Parker Hannifin Corporation

About Parker Hannifin Corporation

Parker Hannifin is a leading global motion-control company dedicated to delivering premier customer service. A Fortune 500 corporation listed on the New York STOCK Exchange (PH), our components and systems comprise over 1,400 product lines that control motion in some 1,000 industrial and aerospace markets. Parker is the only manufacturer to offer its customers a choice of hydraulic, pneumatic, and electromechanical motion-control solutions. Our company has the largest distribution network in its field, with over 7,500 distributors serving nearly 400,000 customers worldwide.

Parker's Charter

To be a leading worldwide manufacturer of components and systems for the builders and users of durable goods. More specifically, we will design, market and manufacture products controlling motion, flow and pressure. We will achieve profitable growth through premier customer service.

Product Information

North American customers seeking product information, the location of a nearby distributor, or repair services will receive prompt attention by calling the Parker Product Information Center at our toll-free number: 1-800-C-PARKER (1-800-272-7537). In Europe, call 00800-C-PARKER-H (00800-2727-5374).

The Aerospace Group

is a leader in the development, design, manufacture and servicing of control systems and components for aerospace and related high-technology markets, while achieving growth through premier customer service.



The Climate & Industrial Controls Group

designs, manufactures and markets system-control and fluid-handling components and systems to refrigeration, air-conditioning and industrial customers worldwide.



The Fluid Connectors

Group designs, manufactures and markets rigid and flexible connectors, and associated products used in pneumatic and fluid systems.



The Seal Group designs, manufactures and distributes industrial and commercial sealing devices and related products by providing superior quality and total customer satisfaction.



The Hydraulics Group

designs, produces and markets a full spectrum of hydraulic components and systems to builders and users of industrial and mobile machinery and equipment.



The Filtration Group

designs, manufactures and markets quality filtration and clarification products, providing customers with the best value, quality, technical support, and global availability.



The Automation Group

is a leading supplier of pneumatic and electromechanical components and systems to automation customers worldwide.



The Instrumentation

Group is a global leader in the design, manufacture and distribution of high-quality critical flow components for worldwide process instrumentation, ultra-high-purity, medical and analytical applications.



anything  Parker
Possible.™

Parker Hannifin Corporation
Instrumentation Products Division
1005 A Cleaner Way
Huntsville, AL 35805
Phone: (256) 881-2040
Fax: (256) 881-5730
www.parker.com/ipdus

Catalog 4245-VacuSeal™, 10M, 05/06