

Instrument Pipe & ISO Conversion Fittings

*Catalog 4260
Revised, February 1999*



Instrument Pipe Fittings

Instrument Pipe Fittings

Introduction

Parker Instrumentation Pipe Fittings are designed as leak-free connections for process, power, instrumentation and general plumbing applications. They are manufactured to the highest quality standards and are available in broad ranges of sizes, materials and configurations.

Parker Instrumentation Pipe fittings are made at the Instrumentation Connectors Division of Parker Hannifin in Huntsville, Alabama where strict adherence to quality control programs are maintained. These quality standards are incorporated in a total efficiency program called Parker Targets.

The Parker Targets Program is a measure of the efficiency with which the company transforms materials, employee efforts, machinery and information into customer-satisfying products and services. Consequently, Instrumentation Pipe fittings as products of Parker Targets effectively guarantee to customers that they are receiving the highest quality fittings available.

Material

Parker Pipe Fittings are standard in steel and brass. Other materials may be special ordered within the Parker Quick Response Department. Straight fittings are manufactured from applicable ASTM bar stock specifications shaped fittings are manufactured from close grain forgings.

ISO Conversion Fittings

Introduction

Parker ISO Conversion Fittings are designed to the highest quality standards to allow connections between components and systems which use both NPT and ISO Thread configurations. Conversion fittings are maintained under strict quality control programs.

Design

Parker ISO Conversion Fittings are designed to the most commonly used ISO thread forms. These thread forms are used where pressure tight joints are either made on threads utilizing a thread sealant or where pressure tight joints utilize a peripheral seal on the face of the mating component.

Material

Parker ISO Conversion Fittings are standard in stainless steel and brass. Other materials may be special ordered within the Parker Quick Response Department. Straight fittings are manufactured from applicable ASTM bar stock specifications shaped fittings are manufactured from close grain forgings.



WARNING

FAILURE, IMPROPER SELECTION OR IMPROPER USE OF THE PRODUCTS AND/OR SYSTEMS DESCRIBED HEREIN OR RELATED ITEMS CAN CAUSE DEATH, PERSONAL INJURY AND PROPERTY DAMAGE.

This document and other information from Parker Hannifin Corporation, its subsidiaries and authorized distributors provide product and/or system options for further investigation by users having technical expertise. It is important that you analyze all aspects of your application and review the information concerning the product or system in the current product catalog. Due to the variety of operating conditions and applications for these products or systems, the user, through its own analysis and testing, is solely responsible for making the final selection of the products and systems and assuring that all performance, safety and warning requirements of the application are met.

The products described herein, including without limitation, product features, specifications, designs, availability and pricing, are subject to change by Parker Hannifin Corporation and its subsidiaries at any time without notice.

Offer of Sale

The items described in this document are hereby offered for sale by Parker Hannifin Corporation, its subsidiaries or its authorized distributors. This offer and its acceptance are governed by the provisions stated in the "Offer of Sale".

Visual Index

Pipe Fittings

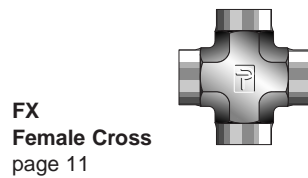
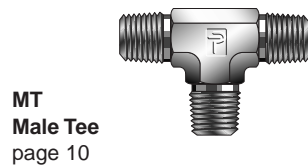
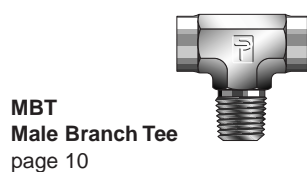
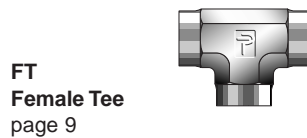
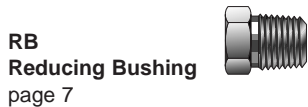
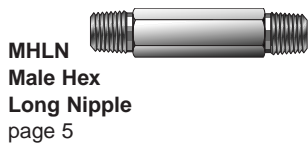

Straight Thread Adapters



**Thread and Tube End
Size Charts**
page 27, 28, 29

**Engineering Report Heat
Code Traceability**
page 30

Visual Index for ISO Conversion Fittings on page 14.

Instrument Pipe Fittings

Features and Technical Data

Parker Instrument Pipe Fittings are precision machined from forgings for elbows, tees and crosses and from bar stock for straight connectors. They are designed to be used for process control and instrumentation connections between pipe sizes and tube sizes.

Features

- Quality engineered for instrumentation applications
- Packaged in sealed, clear plastic shrink wrapped boxes for cleanliness
- Working pressures calculated in accordance with Power Piping Code ANSI B31.1 and Refiner Piping Code ANSI B31.3.
- All pipe threads are National Pipe Taper (NPT) and exceed the requirements of ANSI B1.20.1.

- Rolled male threads for extra strength
- Straight bodies machined from applicable ASTM bar stock specifications
- Shapes machined from close grain forgings
- Size ranges from 1/16" through 2" NPT
- Materials – 316 Stainless Steel, Brass and Steel. (Other materials by special order)
- All exposed threads protected to prevent damage

Nomenclature

Parker Instrument Pipe Fittings part numbers are constructed from symbols that identify the size and style of the fitting and material used.

Example: The part number shown below is for a male hex nipple for 3/8" NPT male pipe and 1/4" NPT male pipe in 316 stainless steel.

Pipe Dimensions

Pipe Size	N.P.T. Pipe Thread	R	E Ref.
1/16	1/16 – 27	.38	.11
1/8	1/8 – 27	.38	.19
1/4	1/4 – 18	.56	.28
3/8	3/8 – 18	.56	.41
1/2	1/2 – 14	.75	.50
3/4	3/4 – 14	.75	.62
1	1 – 11-1/2	.94	.94
1-1/4	1-1/4 – 11-1/2	.97	1.25
1-1/2	1-1/2 – 11-1/2	1.00	1.50
2	2 – 11-1/2	1.03	1.94

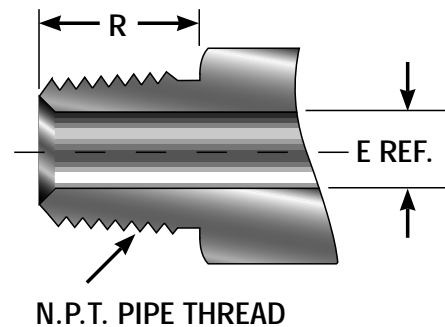

NPT Threads

The National Pipe Taper (NPT) thread has a thread flank angle of 60° inclusive, and is mainly used in the petrochemical and process industries.

NPT – National Pipe Taper threads for connections where pressure-tight joints are made on the threads utilizing a thread sealant.

Generic Thread

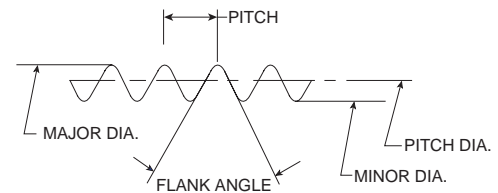

How To Order

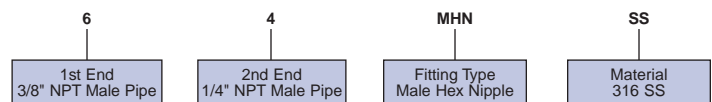

Parker Instrument Pipe Fittings are ordered by part number as listed in this catalog.

Size: Pipe thread sizes are designated by the number of sixteenths of an inch. (3/8 NPT pipe=6/16=6)

Thread Type: All pipe threads are National Pipe Taper (NPT) unless otherwise designated.

Straights and Elbows: Call out the largest pipe end first followed by the smaller pipe size. See MHN example on page 6.

Tees and Crosses: For tees that are the same pipe sizes on all ends the size designation is as follows: 6-6-6 FT-B would be a 3/8" NPT Female Tee in brass.

A 1/4" NPT Female Cross in 316 SS would be a 4 FX-SS.

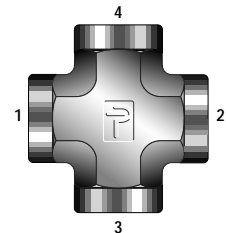

If a reducing tee or cross were specified, each size must be in sequence. First size the largest run (1 to 2) and then the branch (3 to 4).

Example: 6-6-6-4 FX-SS

Material: Basic Material Type (B=Brass, SS=316 Stainless Steel, S=Steel)

Special Fittings: If there is any question as to the fitting desired, particularly for special fitting configurations, it is suggested that a customer print be submitted with the fitting request for quote.

Availability: Items priced in current price list 4260 are carried in stock. Price and delivery for non-standard items quoted on request through the quick response department.

Male Hex Long Nipple MHLN

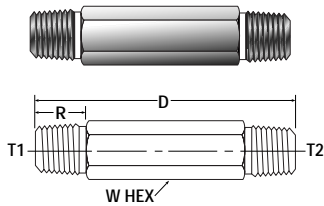

PARKER PART NO.	NPT THREAD MALE		W HEX	D in.	R in.	Working Pressures (PSIG)		
	T ₁	T ₂				Brass	Stainless Steel	Steel
1-1 MHLN-(*)	1/16	1/16	7/16	*	.38	6000	10000	10500
2-2 MHLN-(*)	1/8	1/8	7/16	*	.38	5600	9100	9700
2-2 MHLN-1½	1/8	1/8	7/16	1.50	.38	5600	9100	9700
2-2 MHLN-2	1/8	1/8	7/16	2.00	.38	5600	9100	9700
2-2 MHLN-2½	1/8	1/8	7/16	2.50	.38	5600	9100	9700
4-4 MHLN-(*)	1/4	1/4	5/8	*	.56	4100	7500	8000
4-4 MHLN-2	1/4	1/4	5/8	2.00	.56	4100	7500	8000
4-4 MHLN-2½	1/4	1/4	5/8	2.50	.56	4100	7500	8000
4-4 MHLN-3	1/4	1/4	5/8	3.00	.56	4100	7500	8000
4-4 MHLN-4	1/4	1/4	5/8	4.00	.56	4100	7500	8000
6-6 MHLN-(*)	3/8	3/8	3/4	*	.56	4000	7200	7600
8-8 MHLN-(*)	1/2	1/2	7/8	*	.75	3900	6600	7000
8-8 MHLN-2	1/2	1/2	7/8	2.00	.75	3900	6600	7000
8-8 MHLN-3	1/2	1/2	7/8	3.00	.75	3900	6600	7000

*Specify Length

Male Close Nipple MCN

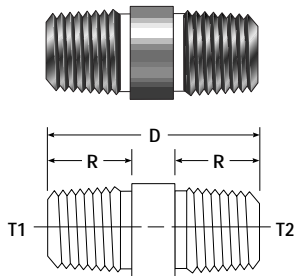

PARKER PART NO.	NPT THREAD MALE	D	R	Working Pressures (PSIG)		
				Brass	Stainless Steel	Steel
1-1 MCN	1/16	.75	.34	6000	10000	10500
2-2 MCN	1/8	.75	.34	5600	9100	9700
4-4 MCN	1/4	1.13	.49	4100	7500	8000
6-6 MCN	3/8	1.13	.48	4000	7200	7600
8-8 MCN	1/2	1.50	.66	3900	6600	7000
12-12 MCN	3/4	1.50	.66	3800	6400	6800
16-16 MCN	1	1.88	.84	2700	4600	4900

Adapter RA

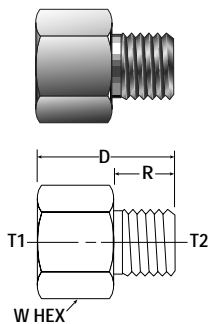

PARKER PART NO.	NPT THREAD		W HEX	D	R	Working Pressures (PSIG)		
	FEMALE T ₁	MALE T ₂				Brass	Stainless Steel	Steel
2-1 RA	1/8	1/16	5/8	1.03	.38	4000	6400	6800
2-2 RA	1/8	1/8	5/8	1.03	.38	4000	6400	6800
4-1 RA	1/4	1/16	3/4	1.20	.38	4300	6600	7000
4-2 RA	1/4	1/8	3/4	1.20	.38	4300	6600	7000
4-4 RA	1/4	1/4	3/4	1.39	.56	4300	6600	7000
6-1 RA	3/8	1/16	7/8	1.25	.38	3500	5300	5600
6-2 RA	3/8	1/8	7/8	1.25	.38	3500	5300	5600
6-4 RA	3/8	1/4	7/8	1.44	.56	3500	5300	5600
6-6 RA	3/8	3/8	7/8	1.44	.56	3500	5300	5600
8-2 RA	1/2	1/8	1-1/8	1.50	.38	3600	5200	5500
8-4 RA	1/2	1/4	1-1/8	1.69	.56	3600	5200	5500
8-6 RA	1/2	3/8	1-1/8	1.69	.56	3600	5200	5500
8-8 RA	1/2	1/2	1-1/8	1.88	.75	3600	5200	5500
12-2 RA	3/4	1/8	1-3/8	1.56	.38	3000	4300	4600
12-4 RA	3/4	1/4	1-3/8	1.75	.56	3000	4300	4600
12-6 RA	3/4	3/8	1-3/8	1.75	.56	3000	4300	4600
12-8 RA	3/4	1/2	1-3/8	1.94	.75	3000	4300	4600
16-2 RA	1	1/8	1-5/8	1.81	.38	3100	4500	4800
16-4 RA	1	1/4	1-5/8	2.00	.56	3100	4500	4800
16-6 RA	1	3/8	1-5/8	2.00	.56	3100	4500	4800
16-8 RA	1	1/2	1-5/8	2.19	.75	3100	4500	4800
16-12 RA	1	3/4	1-5/8	2.19	.75	3100	4500	4800
16-16 RA	1	1	1-5/8	2.38	.94	3100	4500	4800
20-16 RA	1-1/4	1	2	2.47	.94	2300	3500	3700

Dimensions for reference only, subject to change.

Instrument Pipe Fittings

Male Hex Nipple MHN

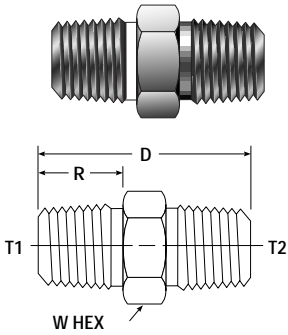

PARKER PART NO.	NPT THREAD MALE		W HEX	D in.	R in.	Working Pressures (PSIG)		
	T ₁	T ₂				Brass	Stainless Steel	Steel
1-1 MHN	1/16	1/16	7/16	1.06	.38	6000	10000	10500
2-1 MHN	1/8	1/16	7/16	1.06	.38	5600	9100	9700
2-2 MHN	1/8	1/8	7/16	1.06	.38	5600	9100	9700
4-1 MHN	1/4	1/16	5/8	1.25	.56/.38	4100	7500	8000
4-2 MHN	1/4	1/8	5/8	1.25	.56/.38	4100	7500	8000
4-4 MHN	1/4	1/4	5/8	1.45	.56	4100	7500	8000
6-1 MHN	3/8	1/16	3/4	1.27	.56/.38	4000	7200	7600
6-2 MHN	3/8	1/8	3/4	1.27	.56/.38	4000	7200	7600
6-4 MHN	3/8	1/4	3/4	1.45	.56	4000	7200	7600
6-6 MHN	3/8	3/8	3/4	1.45	.56	4000	7200	7600
8-2 MHN	1/2	1/8	7/8	1.52	.75/.38	3900	6600	7000
8-4 MHN	1/2	1/4	7/8	1.70	.75/.56	3900	6600	7000
8-6 MHN	1/2	3/8	7/8	1.70	.75/.56	3900	6600	7000
8-8 MHN	1/2	1/2	7/8	1.89	.75	3900	6600	7000
12-2 MHN	3/4	1/8	1-1/8	1.59	.75/.38	3800	6400	6800
12-4 MHN	3/4	1/4	1-1/8	1.78	.75/.56	3800	6400	6800
12-6 MHN	3/4	3/8	1-1/8	1.78	.75/.56	3800	6400	6800
12-8 MHN	3/4	1/2	1-1/8	1.97	.75	3800	6400	6800
12-12 MHN	3/4	3/4	1-1/8	1.97	.75	3800	6400	6800
16-2 MHN	1	1/8	1-3/8	1.78	.94/.38	2700	4600	4900
16-4 MHN	1	1/4	1-3/8	1.97	.94/.56	2700	4600	4900
16-6 MHN	1	3/8	1-3/8	1.97	.94/.56	2700	4600	4900
16-8 MHN	1	1/2	1-3/8	2.16	.94/.75	2700	4600	4900
16-12 MHN	1	3/4	1-3/8	2.09	.94/.75	2700	4600	4900
16-16 MHN	1	1	1-3/8	2.34	.94	2700	4600	4900
20-16 MHN	1-1/4	1	1-3/4	2.45	.97/.94	2000	3500	3700
20-20 MHN	1-1/4	1-1/4	1-3/4	2.48	.97	2000	3500	3700
24-24 MHN	1-1/2	1-1/2	2	2.61	1.00	1800	2900	3100

Female Hex Coupling FHC

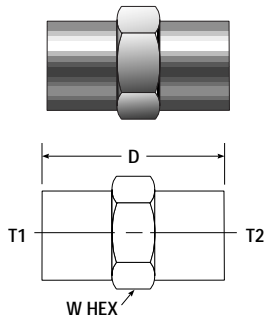

PARKER PART NO.	NPT THREAD FEMALE		W HEX	D	Working Pressures (PSIG)		
	T ₁	T ₂			Brass	Stainless Steel	Steel
1-1 FHC	1/16	1/16	1/2	.75	4500	7500	8000
2-1 FHC	1/8	1/16	5/8	.75	4000	6400	6800
2-2 FHC	1/8	1/8	5/8	.75	4000	6400	6800
4-1 FHC	1/4	1/16	3/4	.92	4300	6600	7000
4-2 FHC	1/4	1/8	3/4	.94	4300	6600	7000
4-4 FHC	1/4	1/4	3/4	1.13	4300	6600	7000
6-1 FHC	3/8	1/16	7/8	.95	3500	5300	5600
6-2 FHC	3/8	1/8	7/8	1.03	3500	5300	5600
6-4 FHC	3/8	1/4	7/8	1.13	3500	5300	5600
6-6 FHC	3/8	3/8	7/8	1.13	3500	5300	5600
8-2 FHC	1/2	1/8	1-1/8	1.22	3600	5200	5500
8-4 FHC	1/2	1/4	1-1/8	1.38	3600	5200	5500
8-6 FHC	1/2	3/8	1-1/8	1.50	3600	5200	5500
8-8 FHC	1/2	1/2	1-1/8	1.50	3600	5200	5500
12-2 FHC	3/4	1/8	1-3/8	1.39	3000	4300	4600
12-4 FHC	3/4	1/4	1-3/8	1.55	3000	4300	4600
12-6 FHC	3/4	3/8	1-3/8	1.69	3000	4300	4600
12-8 FHC	3/4	1/2	1-3/8	1.88	3000	4300	4600
12-12 FHC	3/4	3/4	1-3/8	1.53	3000	4300	4600
16-2 FHC	1	1/8	1-5/8	1.44	3100	4500	4800
16-4 FHC	1	1/4	1-5/8	1.63	3100	4500	4800
16-6 FHC	1	3/8	1-5/8	1.63	3100	4500	4800
16-8 FHC	1	1/2	1-5/8	1.77	3100	4500	4800
16-12 FHC	1	3/4	1-5/8	1.72	3100	4500	4800
16-16 FHC	1	1	1-5/8	1.89	3100	4500	4800
20-16 FHC	1-1/4	1	2	1.94	2300	3500	3700
20-20 FHC	1-1/4	1-1/4	2	1.94	2300	3500	3700
24-24 FHC	1-1/2	1-1/2	2-3/8	1.94	2100	3200	3400

Dimensions for reference only, subject to change.

Reducing Bushing RB

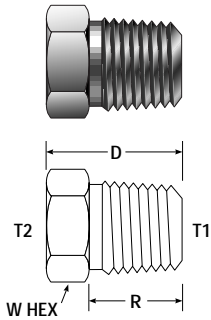

PARKER PART NO.	NPT THREAD		W HEX	D	R	Working Pressures (PSIG)		
	MALE T ₁	FEMALE T ₂				Brass	Stainless Steel	Steel
2-1 RB	1/8	1/16	7/16	.63	.38	2900	6400	6800
4-1 RB	1/4	1/16	5/8	.86	.56	4100	7500	8000
4-2 RB	1/4	1/8	5/8	.86	.56	3600	6000	6400
6-1 RB	3/8	1/16	3/4	.86	.56	4000	7200	7600
6-2 RB	3/8	1/8	3/4	.86	.56	4000	6400	6800
6-4 RB	3/8	1/4	3/4	.86	.56	3000	5300	5600
8-2 RB	1/2	1/8	7/8	1.11	.75	3900	6600	6800
8-4 RB	1/2	1/4	7/8	1.11	.75	3900	6400	7000
8-6 RB	1/2	3/8	7/8	1.11	.75	2800	4600	4900
12-2 RB	3/4	1/8	1-1/8	1.17	.75	3800	6400	6800
12-4 RB	3/4	1/4	1-1/8	1.17	.75	3800	6400	6800
12-6 RB	3/4	3/8	1-1/8	1.17	.75	3500	5300	5600
12-8 RB	3/4	1/2	1-1/8	1.17	.75	2800	4900	5200
16-2 RB	1	1/8	1-3/8	1.36	.94	2700	4600	4900
16-4 RB	1	1/4	1-3/8	1.36	.94	2700	4600	4900
16-6 RB	1	3/8	1-3/8	1.36	.94	2700	4600	4900
16-8 RB	1	1/2	1-3/8	1.36	.94	2700	4600	4900
16-12 RB	1	3/4	1-3/8	1.36	.94	2500	4200	4500
20-12 RB	1-1/4	3/4	1-3/4	1.47	.97	2000	3500	3700
20-16 RB	1-1/4	1	1-3/4	1.47	.97	2000	3500	3700
24-16 RB	1-1/2	1	2	1.58	1.00	1800	2900	3100
24-20 RB	1-1/2	1-1/4	2	1.58	1.00	1700	2700	2800

Male Elbow ME

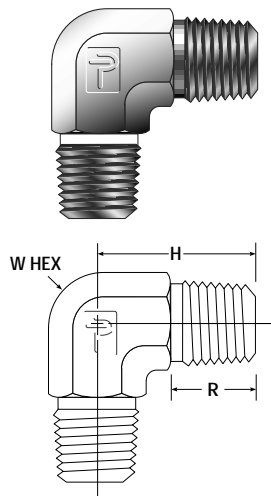

PARKER PART NO.	NPT THREAD MALE	W HEX	H	R	Working Pressures (PSIG)		
					Brass	Stainless Steel	Steel
1-1 ME	1/16	3/8	.66	.38	5500	9500	10100
2-2 ME	1/8	7/16	.76	.38	5000	9100	9700
4-4 ME	1/4	9/16	1.09	.56	4100	7500	8000
6-6 ME	3/8	3/4	1.22	.56	4000	7200	7600
8-8 ME	1/2	7/8	1.47	.75	3100	5800	6200
12-12 ME	3/4	1-1/16	1.59	.75	3400	6400	6800
16-16 ME	1	1-5/16	1.97	.94	2700	4600	4900

Dimensions for reference only, subject to change.

Instrument Pipe Fittings

Female Elbow FE

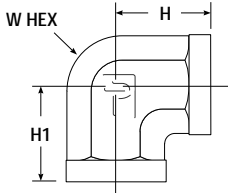

PARKER PART NO.	NPT THREAD FEMALE	W HEX	H	H1	Working Pressures (PSIG)		
					Brass	Stainless Steel	Steel
1-1 FE	1/16	7/16	.50	.50	3800	7000	7500
2-1 FE	1/8 - 1/16	9/16	.66	.66	2900	5500	5900
2-2 FE	1/8	9/16	.66	.66	2900	5500	5900
4-2 FE	1/4 - 1/8	3/4	.88	.88	2900	5500	5900
4-4 FE	1/4	3/4	.88	.88	3000	5600	6000
6-6 FE	3/8	7/8	1.02	1.02	2700	5000	5300
8-8 FE	1/2	1-1/16	1.23	1.23	2500	4500	4800
12-12 FE	3/4	1-5/16	1.36	1.36	2000	3500	3700
16-16 FE	1	1-5/8	1.63	1.63	2300	3900	4200
20-20 FE	1-1/4	1-7/8	1.70	1.70	1900	3100	3300
24-24 FE	1-1/2	2-1/2	2.08	2.08	1700	2500	2600

Female Elbow 45° FVE

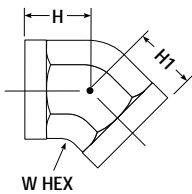
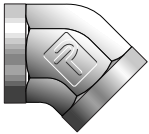

PARKER PART NO.	NPT THREAD FEMALE	W HEX	H	H1	Working Pressures (PSIG)		
					Brass	Stainless Steel	Steel
1-1 FVE	1/16	7/16	.47	.47	3800	7000	7500
2-2 FVE	1/8	9/16	.47	.47	2900	5500	5900
4-4 FVE	1/4	3/4	.69	.69	3000	5600	6000
6-6 FVE	3/8	7/8	.75	.75	2700	5000	5300
8-8 FVE	1/2	1-1/16	.94	.94	2500	4500	4800
12-12 FVE	3/4	1-5/16	1.00	1.00	2000	3500	3700
16-16 FVE	1	1-5/8	1.19	1.19	2300	3900	4200

Street Elbow SE

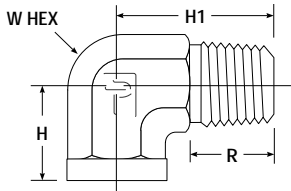
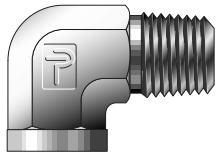

PARKER PART NO.	NPT THREAD		W HEX	H	H1	R	Working Pressures (PSIG)		
	MALE	FEMALE					Brass	Stainless Steel	Steel
1-1 SE	1/16	1/16	9/16	.66	.72	.38	3800	7000	7500
2-1 SE	1/8	1/16	9/16	.66	.78	.38	3800	7000	7500
2-2 SE	1/8	1/8	9/16	.66	.78	.38	2900	5500	5900
4-1 SE	1/4	1/16	9/16	.66	1.09	.56	3800	7000	7500
4-2 SE	1/4	1/8	9/16	.66	1.09	.56	2900	5500	5900
4-4 SE	1/4	1/4	3/4	.88	1.09	.56	3000	5600	6000
6-1 SE	3/8	1/16	3/4	.88	1.09	.56	3800	7000	7500
6-2 SE	3/8	1/8	3/4	.88	1.22	.58	2900	5500	5900
6-4 SE	3/8	1/4	3/4	.88	1.22	.56	3000	5500	6000
6-6 SE	3/8	3/8	7/8	1.02	1.22	.56	2700	5600	5300
8-2 SE	1/2	1/8	7/8	.95	1.47	.75	2900	5000	5900
8-4 SE	1/2	1/4	7/8	.95	1.47	.75	3000	5600	6000
8-6 SE	1/2	3/8	7/8	1.23	1.47	.75	2700	5000	5300
8-8 SE	1/2	1/2	1-1/16	1.23	1.47	.75	2500	4500	4800
12-2 SE	3/4	1/8	1-1/16	1.00	1.59	.75	2900	5500	5900
12-4 SE	3/4	1/4	1-1/16	1.00	1.59	.75	3000	5600	6000
12-6 SE	3/4	3/8	1-1/16	1.23	1.59	.75	2700	5000	5300
12-8 SE	3/4	1/2	1-1/16	1.23	1.59	.75	2500	4500	4800
12-12 SE	3/4	3/4	1-5/16	1.36	1.59	.75	2000	3500	3700
16-2 SE	1	1/8	1-5/16	1.63	1.97	.94	2700	5500	5900
16-4 SE	1	1/4	1-5/16	1.63	1.97	.94	2700	5600	6000
16-6 SE	1	3/8	1-5/16	1.50	1.97	.94	2700	5000	5300
16-8 SE	1	1/2	1-5/16	1.63	1.97	.94	2500	4500	4800
16-12 SE	1	3/4	1-5/16	1.36	1.97	.94	2000	3500	3700
16-16 SE	1	1	1-5/8	1.63	1.97	.94	2300	3900	4200
20-20 SE	1-1/4	1-1/4	1-7/8	1.70	2.38	.97	1900	3100	3300

Dimensions for reference only, subject to change.

Street Elbow 45° SVE

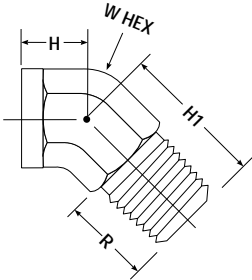
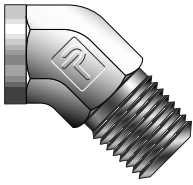

PARKER PART NO.	NPT THREAD		W HEX	H	H1	R	Working Pressures (PSIG)		
	MALE	FEMALE					Brass	Stainless Steel	Steel
1-1 SVE	1/16	1/16	7/16	.47	.66	.38	3800	7000	7500
2-2 SVE	1/8	1/8	9/16	.47	.72	.38	2900	5500	5900
4-4 SVE	1/4	1/4	3/4	.63	1.05	.56	3000	5600	6000
6-6 SVE	3/8	3/8	7/8	.72	1.06	.56	2700	5000	5300
8-8 SVE	1/2	1/2	1-1/16	.91	1.34	.75	2500	4500	4800
12-12 SVE	3/4	3/4	1-5/16	.97	1.38	.75	2000	3500	3700
16-16 SVE	1	1	1-5/8	1.13	1.72	.94	2300	3900	4200

Female Tee FT

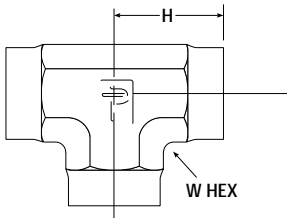

PARKER PART NO.	NPT THREAD FEMALE	W HEX	H	Working Pressures (PSIG)		
				Brass	Stainless Steel	Steel
1-1-1 FT	1/16	7/16	.50	3800	7000	7500
2-2-2 FT	1/8	9/16	.66	2900	5500	5900
4-4-4 FT	1/4	3/4	.88	3000	5600	6000
6-6-6 FT	3/8	7/8	1.02	2700	5000	5300
8-8-8 FT	1/2	1-1/16	1.23	2500	4500	4800
12-12-12 FT	3/4	1-5/16	1.36	2000	3500	3700
16-16-16 FT	1	1-5/8	1.63	2300	3900	4200
20-20-20 FT	1-1/4	1-7/8	1.70	1900	3100	3300
24-24-24 FT	1-1/2	2-1/2	2.08	1700	2500	3600

Street Tee ST

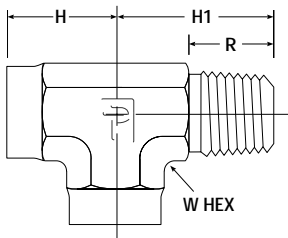
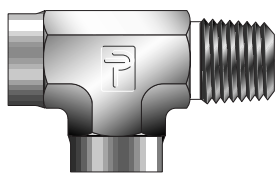

PARKER PART NO.	NPT THREAD		W HEX	H	H1	R	Working Pressures (PSIG)		
	MALE	FEMALE					Brass	Stainless Steel	Steel
1-1-1 ST	1/16	1/16	7/16	.50	.72	.38	3800	7000	7500
2-2-2 ST	1/8	1/8	9/16	.66	.78	.38	2900	5500	5900
4-4-4 ST	1/4	1/4	3/4	.88	1.09	.56	3000	5600	6000
6-6-6 ST	3/8	3/8	7/8	1.02	1.22	.56	2700	5000	5300
8-8-8 ST	1/2	1/2	1-1/16	1.23	1.47	.75	2500	4500	4800
12-12-12 ST	3/4	3/4	1-5/16	1.36	1.59	.75	2000	3500	3700
16-16-16 ST	1	1	1-5/8	1.63	1.97	.94	2300	3900	4200

Dimensions for reference only, subject to change.

Instrument Pipe Fittings

Male Branch Tee MBT

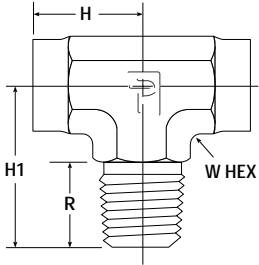
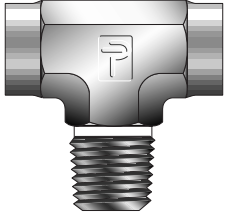

PARKER PART NO.	NPT THREAD		W HEX	H	H1	R	Working Pressures (PSIG)		
	MALE	FEMALE					Brass	Stainless Steel	Steel
1-1-1 MBT	1/16	1/16	7/16	.50	.72	.38	3800	7000	7500
2-2-2 MBT	1/8	1/8	9/16	.66	.78	.38	2900	5500	5900
4-4-4 MBT	1/4	1/4	3/4	.88	1.09	.56	3000	5600	6000
6-6-6 MBT	3/8	3/8	7/8	1.02	1.22	.56	2700	5000	5300
8-8-8 MBT	1/2	1/2	1-1/16	1.23	1.47	.75	2500	4500	4800
12-12-12 MBT	3/4	3/4	1-5/16	1.36	1.59	.75	2000	3500	3700
16-16-16 MBT	1	1	1-5/8	1.63	1.97	.94	2300	3900	4200

Male Tee MT

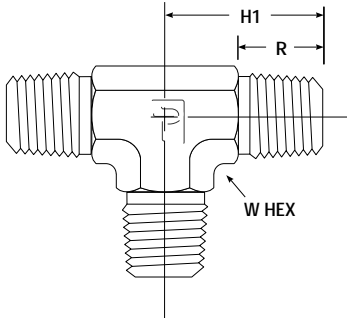
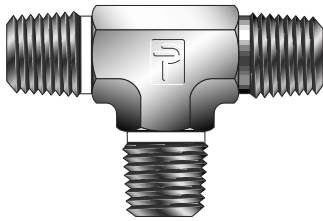

PARKER PART NO.	NPT THREAD MALE	W HEX	H1	R	Working Pressures (PSIG)		
					Brass	Steel	Stainless Steel
1-1-1 MT	1/16	5/16	.72	.38	5500	9500	10100
2-2-2 MT	1/8	7/16	.76	.38	5000	9100	9700
4-4-4 MT	1/4	9/16	1.09	.56	4100	7500	8000
6-6-6 MT	3/8	3/4	1.22	.56	4000	7200	7600
8-8-8 MT	1/2	7/8	1.47	.75	3100	5800	6200
12-12-12 MT	3/4	1-1/16	1.59	.75	3400	6400	6800
16-16-16 MT	1	1-5/16	1.97	.94	2700	4600	4900
20-20-20 MT	1-1/4	1-5/8	2.22	.97	2000	3500	3700
24-24-24 MT	1-1/2	1-7/8	2.64	1.00	1800	2900	3100

Dimensions for reference only, subject to change.

Female Cross FX

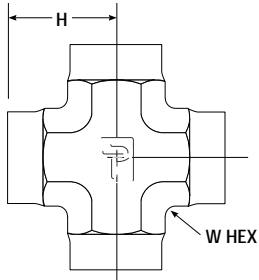
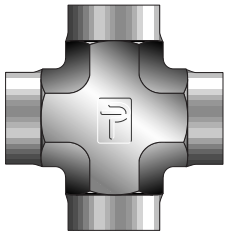

PARKER PART NO.	NPT THREAD FEMALE	W HEX	H	Working Pressures (PSIG)		
				Brass	Stainless Steel	Steel
1 FX	1/16	7/16	.50	3800	7000	7500
2 FX	1/8	9/16	.66	2900	5500	5900
4 FX	1/4	3/4	.88	3000	5600	6000
6 FX	3/8	7/8	1.06	2700	5000	5300
8 FX	1/2	1-1/16	1.23	2500	4500	4800
12 FX	3/4	1-5/16	1.36	2000	3500	3700
16 FX	1	1-5/8	1.63	2300	3900	4200

Pipe Cap CP

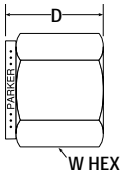

PARKER PART NO.	NPT THREAD FEMALE	W HEX	D	Working Pressures (PSIG)		
				Brass	Stainless Steel	Steel
1 CP	1/16	7/16	.50	4500	7500	8000
2 CP	1/8	9/16	.75	4000	6400	6800
4 CP	1/4	3/4	.91	4300	6600	7000
6 CP	3/8	7/8	1.03	3500	5300	5600
8 CP	1/2	1-1/16	1.34	3600	5200	5500
12 CP	3/4	1-1/4	1.44	3000	4300	4600
16 CP	1	1-5/8	1.63	3100	4500	4800

Hex Head Plug PH

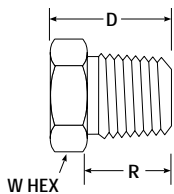
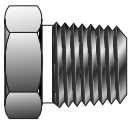

PARKER PART NO.	NPT THREAD MALE	W HEX	D	R	Working Pressures (PSIG)		
					Brass	Steel	Stainless Steel
1 PH	1/16	3/8	.54	.38	6000	10000	10500
2 PH	1/8	7/16	.56	.38	5600	9100	9700
4 PH	1/4	9/16	.75	.56	4100	7500	8000
6 PH	3/8	11/16	.78	.56	4000	7200	7600
8 PH	1/2	7/8	.97	.75	3900	6600	7000
12 PH	3/4	1-1/16	1.06	.75	3800	6400	6800
16 PH	1	1-5/16	1.25	.94	2700	4600	4900

Dimensions for reference only, subject to change.

Instrument Pipe Fittings

Hollow Hex Plug PHH

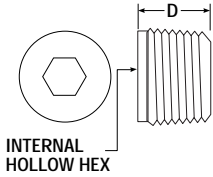

PARKER PART NO.	NPT THREAD FEMALE	W INTERNAL HEX	D	Working Pressures (PSIG)		
				Brass	Stainless Steel	Steel
1 PHH	1/16	5/32	.30	6000	10000	10500
2 PHH	1/8	3/16	.30	5600	9100	9700
4 PHH	1/4	1/4	.47	4100	7500	8000
6 PHH	3/8	5/16	.47	4000	7200	7600

Straight Thread Adapters

Hex Head Plug P5ON

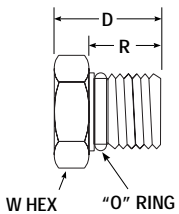
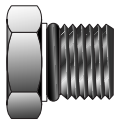

PARKER PART NO.	INTER-CHANGES WITH	PORT THD UN/UNF-2A	W HEX	D	R	*D2 DRILL	*L2	O-RING
4 P5ON	4 PST	7/16-20	9/16	0.67	0.36	0.203	0.41	3-904
6 P5ON	6 PST	9/16-18	11/16	0.73	0.39	0.297	0.44	3-906
8 P5ON	8 PST	3/4-16	7/8	0.80	0.44	0.422	0.44	3-908
12 P5ON	12 PST	1-1/16-12	1-1/4	1.09	0.59	0.656	0.59	3-912
16 P5ON	16 PST	1-5/16-12	1-1/2	1.13	0.59	0.875	0.50	3-916

*D2 drill and L2 depth are optional manufacturing method per SAE.

Hollow Hex Plug HP5ON

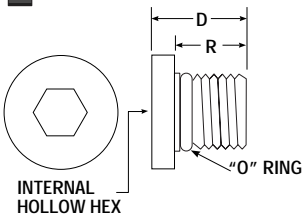
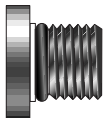

PARKER PART NO.	INTER-CHANGES WITH	PORT THD UN/UNF-2A	INTERNAL HEX	R	D	X DIA.	O-RING
4 HP5ON	4 HPST	7/16-20	3/16	0.36	0.47	0.56	3-904
6 HP5ON	6 HPST	9/16-18	1/4	0.39	0.50	0.69	3-906
8 HP5ON	8 HPST	3/4-16	5/16	0.44	0.58	0.88	3-908
12 HP5ON	12 HPST	1-1/16-12	9/16	0.59	0.77	1.25	3-912
16 HP5ON	16 HPST	1-5/16-12	5/8	0.59	0.77	1.50	3-916

Dimensions for reference only, subject to change.

Straight Thread Reducer/Expander F5OG5

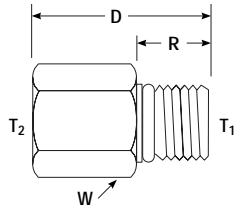
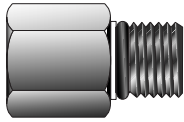

PARKER PART NO.	INTER-CHANGES WITH	T2 PORT THD UN/UNF-2B	T1 PORT THD UN/UNF-2A	W HEX	D2 DRILL	D	R	O-RING
6-4 F5OG5	6-RBST-4	7/16-20	9/16-18	11/16	.297	1.03	.36	3-904
8-4 F5OG5	8-RBST-4	7/16-20	3/4-16	7/8	.375	1.09	.36	3-904
12-8 F5OG5	12-RBST-8	3/4-16	1-1/16-12	1-1/4	.625	1.00	.44	3-908
16-12 F5OG5	16-RBST-12	1-1/16-12	1-5/16-12	1-1/2	.750	1.75	.59	3-912

*D2 drill is optional manufacturing method per SAE.

Male SAE Straight Thread to Female NPT Thread GOA

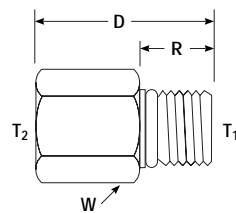
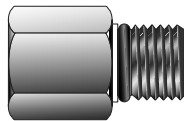

PARKER PART NO.	INTER-CHANGES WITH	T1 STRAIGHT THREAD SIZE	T2 - NPT FEMALE PIPE SIZE	D	R	E MINIMUM OPENING	W HEX	ST O-RING UNIFORM SIZE #
4-4 GOA	4SAE-7-4	7/16-20	1/4	1.19	.36	.20	3/4	3-904
6-6 GOA	6SAE-7-6	9/16-18	3/8	1.26	.39	.30	7/8	3-906
8-8 GOA	8-SAE-7-8	3/4-16	1/2	1.50	.44	.39	1-1/8	3-908
12-12 GOA	12-SAE-7-12	1-1/16-12	3/4	1.83	.59	.66	1-1/4	3-912
16-16 GOA	16-SAE-7-16	1-5/16-12	1	1.88	.59	.88	1-5/8	3-916

Includes "O"-ring.

Male Connector to SAE Straight Thread

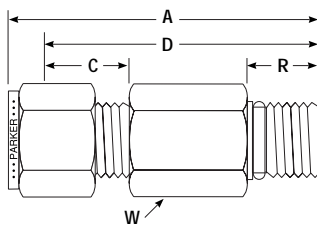
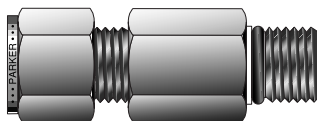

PARKER CPI™ PART NO.	PARKER A-LOK® PART NO.	INTER-CHANGES WITH	TUBE O.D.	STRAIGHT THREAD SIZE	W HEX	†A	†C	D	R	O-RING DASH NO.
4-4 ZH3BA	4-4 ZH3LA	400-IL-4ST	1/4	7/16-20	9/16	2.26	.70	1.97	.36	3-904
5-5 ZH3BA	5-5 ZH3LA	500-IL-5ST	5/16	1/2-20	5/8	2.32	.73	2.03	.36	3-905
6-6 ZH3BA	6-6 ZH3LA	600-IL-6ST	3/8	9/16-18	11/16	2.48	.76	2.19	.39	3-906
8-8 ZH3BA	8-8 ZH3LA	810-IL-8ST	1/2	3/4-16	7/8	2.99	.87	2.58	.44	3-908
10-10 ZH3BA	10-10 ZH3LA	1010-IL-10ST	5/8	7/8-14	1	3.34	.87	2.94	.50	3-910
12-12 ZH3BA	12-12 ZH3LA	1210-IL-12ST	3/4	1-1/16-12	1-1/4	3.88	.87	3.48	.59	3-912
14-14 ZH3BA	14-14 ZH3LA	1410-IL-14ST	7/8	1-3/16-12	1-3/8	4.07	.87	3.67	.59	3-914
16-16 ZH3BA	16-16 ZH3LA	1610-IL-16ST	1	1-5/16-12	1-1/2	4.35	1.05	3.86	.59	3-916

Includes body, nut, ferrule and "O"-ring.

†Average value.

"O"-Ring Seals

All standard "O"-Rings are Buna-N material 70 Dura-meter hardness. For other materials state material after part number.

Dimensions for reference only, subject to change.

Visual Index

ISO Fitting Nomenclature
page 15

Typical Fastening Threads
page 16

BSP Thread Forms
page 17

ISO Conversion Fittings

NPT Male/
BSP Taper Male
page 18

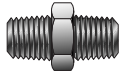

NPT Male/
BSPP Male
page 18

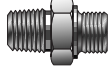

NPT Female/
BSP Taper Male
page 18

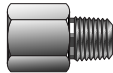

NPT Female/
BSPP Male
page 19

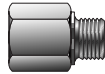

BSP Taper
Female/
NPT Male
page 19

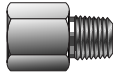

BSPP Female/
NPT Male
page 19



BSP Taper
Male Hex Pipe Plug
page 20



BSPP Parallel
Male Hex Pipe Plug
page 20



ISO Thread/Fractional Tube Connectors

BSP Taper
Male Connector
page 21

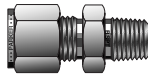

BSPP Male
Connector
page 21

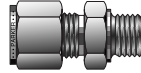

BSP Taper
Female Connector
page 21

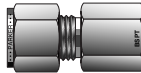

BSPP Female
Gauge Connector
page 22

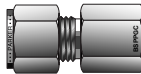

BSP Taper
Male Elbow
page 22

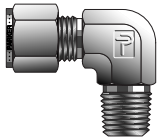

BSPP Male
Elbow (Positionable)
page 23

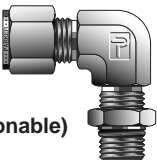

BSPP Male
Run Tee
(Positionable)
page 23

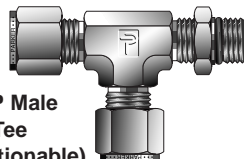

BSPP Male
Branch Tee
(Positionable)
page 24

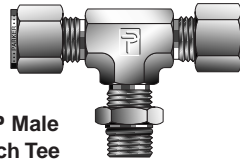

BSP Taper
Male Adapter
page 24

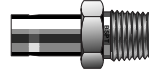

BSPP Male
Adapter
page 25

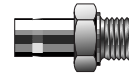

BSP Taper
Female Adapter
page 25

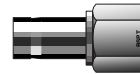

BSPP Female
Adapter
page 25

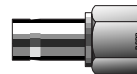

BSPP Female
Gauge Adapter
page 26

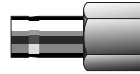

Sealing Washers

Bonded Seals
(Stainless)
page 26



Copper
Washers/Male
page 26



Copper
Washers/Female
page 26



Thread and Tube End
Size Charts
page 27, 28, 29

Engineering Report Heat
Code Traceability
page 30

Visual Index for Instrument Pipe Fittings on page 3.

Parker ISO Fitting Nomenclature

Parker ISO Adapters utilize the same basic part numbering system that you are already familiar with from our CPI™ and A-LOK® Catalogs.

To specify a Parker Instrumentation Connector with an ISO thread form, simply suffix the **size designator** with the **thread form designator** as illustrated.

Build a **CPI™** or **PIPE** part number by filling in the following boxes:

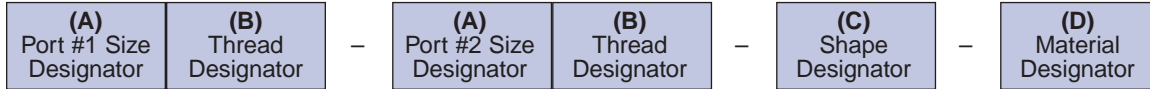

Build an **A-LOK®** part number by filling in the following boxes:

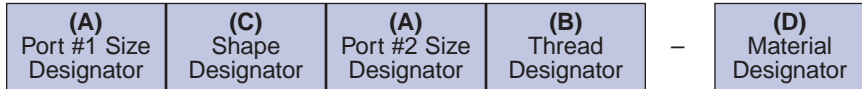

(A) Port Size Designators:

Port sizes are incremented by 1/16" and only the numerator is required to specify a size in a part number.

1 = 1/16"	6 = 3/8"
2 = 1/8"	8 = 1/2"
3 = 3/16"	10 = 5/8"
4 = 1/4"	12 = 3/4"
5 = 5/16"	16 = 1" (larger sizes available)

(B) Thread Type Designators:

Leave **Blank**: Fractional Tube Size

N¹ = NPT per ANSI B1.20.1

K = ISO Taper per; ISO 7/1, BS21, JIS B0203, DIN 2999

R = ISO Parallel per; ISO 228/1+2, DIN 3852 Form A, BS2779 (BSPP), JIS B0202

BR = ISO Parallel per; ISO 228/1+2, DIN 3852 Form B, BS2779 (BSPP), JIS B0202

GC = ISO Parallel, Female Gauge connector

¹N thread type designator is only required for A-LOK® nomenclature

(C) Body Shape Designator:

FBZ = CPI™ Male Connector

MSC = A-LOK® Male Connector

RA = Pipe Reducing Adapter

MHN = Pipe Male Hex Nipple

See Catalog for further detail

(D) Material Designators:

SS = Stainless Steel for CPI™ and Pipe Fittings

316 = Stainless Steel for A-LOK®

B = Brass

Material	Standard
Stainless Steel	ASTM A276 ASME SA 479
Brass	ASTM B16 ASTM B 453

Sealing

BSP Taper threads require the use of a thread sealant.

BSPP threads require a sealing washer. This washer may either be a metal (copper is standard) gasket or a "Bonded Seal" (elastomer bonded to a metal retaining washer).

The **BSPP**, form "A" requires the use of a bonded seal. (Page 26)

The **BSPP**, form "B" (cutting face) may be used with or without a sealing washer.

For applications where the cutting face may not seal or where galling is a potential problem, the use of a washer is suggested.

Example: The Thread Form Designators have been highlighted in the following examples for easy recognition.

4-4 K FBZ-SS	1/4" CPI™ Tube Fitting by 1/4" BSPT Pipe Thread
6-4 R RA-SS	3/8" Female NPT by 1/4" BSPP (form A) Reducing Adapter A Bonded Seal should be used with this fitting. (Page 26)
6MSC4 BR -316	3/8" A-LOK® Tube Fitting by 1/4" BSPP (form B) A Copper Washer should be used with this fitting. (Page 26)

Typical Fastening Threads

BSP threads

BSPP Parallel and BSP Taper threads have a thread flank angle of 55° inclusive.

BSPP – British Standard Pipe Parallel threads for tubes and fittings where pressure-tight joints are not made on the thread, i.e., a peripheral seal is used.

BSP Taper – British Standard Pipe Taper threads for tubes and fittings where pressure-tight joints are made on the threads.

Comparison of Thread Forms

NPT Thread Size	Threads per Inch	BSPP	BSPT	Threads per Inch
		Thread Size		
1/8	27	1/8	1/8	28
1/4	18	1/4	1/4	19
3/8	18	3/8	3/8	19
1/2	14	1/2	1/2	14
3/4	14	3/4	3/4	14
1	11 1/2	1	1	11
1 1/4	11 1/2	1 1/4	1 1/4	11
1 1/2	11 1/2	1 1/2	1 1/2	11

Generic Thread

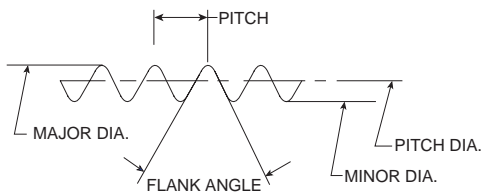

American Standard Pipe Thread (NPT)

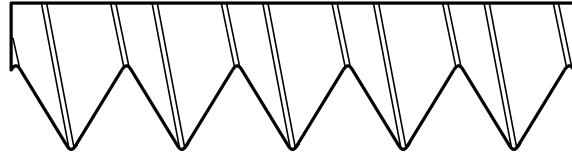

- 60° inclusive thread flank angle
- Pitch measured in inches
- Truncation of root and crest are flat
- Taper angle 1°47'

(ISO 7/1)

BSPT

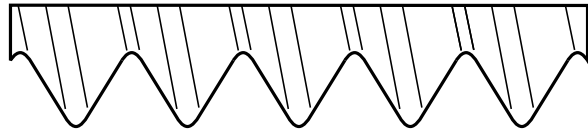

- 55° inclusive thread flank angle
- Pitch measured in inches
- Truncation of root and crest are round
- Taper angle 1°47'

(ISO 228/1)

BSPP

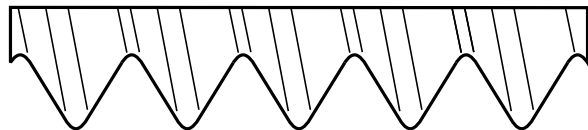

- 55° inclusive thread flank angle
- Pitch measured in inches
- Truncation of root and crest are round
- Diameter measured in inches

BSPP Thread Forms

Form A

A self centering taper is used at the hex which centers a "Bonded" washer (usually metal and elastomer) to seal to the surface surrounding the female thread.

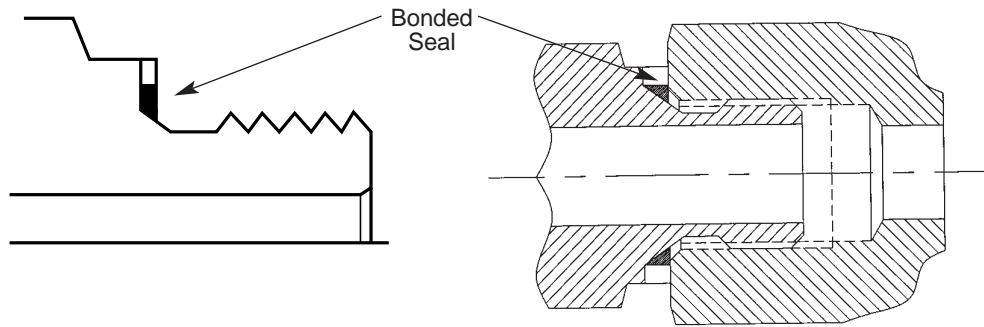

Form B

A metal gasket (usually copper) performs the seal between the face of the body and the face of the female threaded component. For Form "B" replace "R" in P/N with "BR".

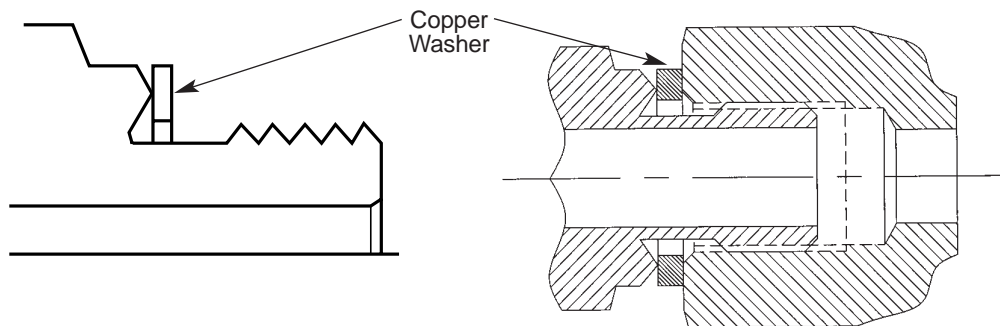

Gauge Port BSPP (Female)

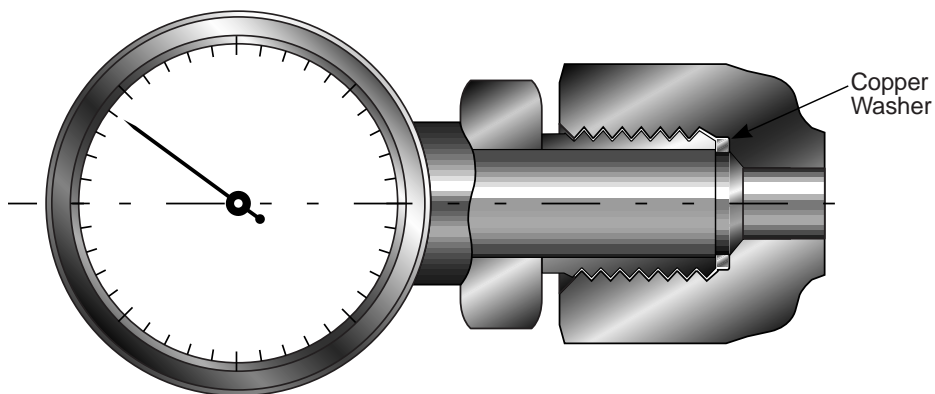

ISO Conversion Fittings

Male Hex Nipple NPT to BSP Taper

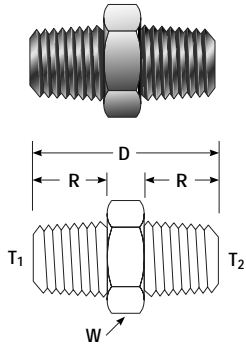

PARKER PART NO.	NPT THREAD T ₁	BSPT THREAD T ₂	W HEX	D	R	Working Pressure			
						Brass		Stainless Steel	
						PSI	BAR	PSI	BAR
2-2K MHN	1/8-27	1/8-28	7/16	1.06	.38	5600	390	9100	630
4-4K MHN	1/4-18	1/4-19	5/8	1.45	.56	4100	280	7500	520
6-6K MHN	3/8-18	3/8-19	3/4	1.45	.56	4000	280	7200	500
8-8K MHN	1/2-14	1/2-14	7/8	1.89	.75	3900	270	6600	460
12-12K MHN	3/4-14	3/4-14	1 1/8	1.97	.75	3800	260	6400	440
16-16K MHN	1-11 1/2	1-11	1 3/8	2.34	.94	2700	190	4600	320

Used to connect a female NPT and a female BSPT threaded component.

Male Hex Nipple NPT to BSPP

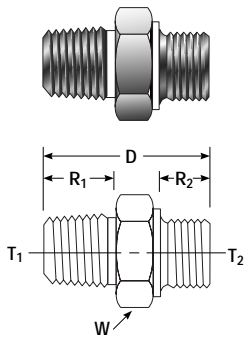

PARKER PART NO.	NPT THREAD T ₁	BSPP THREAD T ₂	W HEX	D	R ₁	R ₂	Working Pressure			
							Brass		Stainless Steel	
							PSI	BAR	PSI	BAR
2-2R MHN	1/8-27	1/8-28	9/16	1.07	.38	.28	5000	340	9100	630
4-4R MHN	1/4-18	1/4-19	3/4	1.44	.56	.44	4000	280	7500	520
6-6R MHN	3/8-18	3/8-19	7/8	1.47	.56	.44	3900	270	7200	500
8-8R MHN	1/2-14	1/2-14	1 1/16	1.78	.75	.56	3800	260	6600	460
12-12R MHN	3/4-14	3/4-14	1 5/16	1.95	.75	.63	3600	250	6400	440
16-16R MHN	1-11 1/2	1-11	1 5/8	2.26	.94	.72	2600	180	4600	320

Used to connect a female NPT and a female BSPP threaded component.

NOTE: Bonded seal, page 26, must be used on BSPP end shown.

Please note the pressure ratings are based on taper threaded ends. The pressure rating for the BSPP ends are dependent on the type of sealing washer used.

Female NPT to Male BSP Taper Adapter

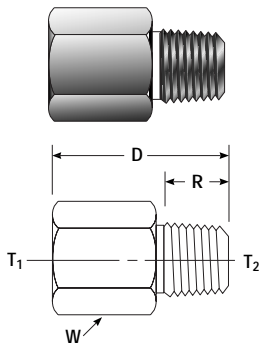

PARKER PART NO.	NPT THREAD T ₁	BSPT THREAD T ₂	W HEX	D	R	Working Pressure			
						Brass		Stainless Steel	
						PSI	BAR	PSI	BAR
2-2K RA	1/8-27	1/8-28	9/16	1.09	.38	3200	220	6100	420
4-4K RA	1/4-18	1/4-19	3/4	1.42	.56	3300	230	6200	430
6-6K RA	3/8-18	3/8-19	7/8	1.49	.56	2600	180	5000	340
8-8K RA	1/2-14	1/2-14	1 1/16	1.94	.75	2400	160	4600	320
12-12K RA	3/4-14	3/4-14	1 5/16	2.00	.75	2300	160	4300	300
16-16K RA	1-11 1/2	1-11	1 5/8	2.28	.94	2200	150	4100	280

Used to connect a male NPT and a female BSPT threaded component.

Dimensions for reference only, subject to change.

Female NPT to Male BSPP Adapter

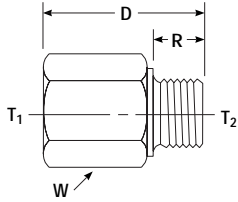
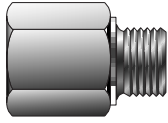

PARKER PART NO.	NPT THREAD T ₁	BSPP THREAD T ₂	W HEX	D	R	Working Pressure			
						Brass		Stainless Steel	
						PSI	BAR	PSI	BAR
2-2R RA	1/8-27	1/8-28	9/16	.99	.28	3200	220	6100	420
4-4R RA	1/4-18	1/4-19	3/4	1.31	.44	3300	230	6200	430
6-6R RA	3/8-18	3/8-19	7/8	1.41	.44	2600	180	5000	340
8-8R RA	1/2-14	1/2-14	1 1/8	1.74	.56	2400	160	4600	320
12-12R RA	3/4-14	3/4-14	1 5/16	2.00	.63	2300	160	4300	300
16-16R RA	1-11 1/2	1-11	1 5/8	2.10	.72	2200	150	4100	280

Used to connect a male NPT and a female BSPP threaded component.
NOTE: Bonded Seal, page 26, must be used with BSPP end shown.

Female BSP Taper to Male NPT Adapter

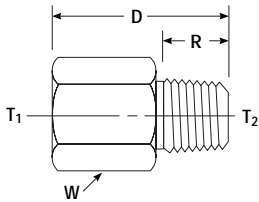
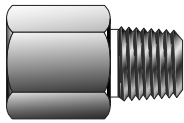

PARKER PART NO.	BSPT THREAD T ₁	NPT THREAD T ₂	W HEX	D	R	Working Pressure			
						Brass		Stainless Steel	
						PSI	BAR	PSI	BAR
2K-2 RA	1/8-28	1/8-27	9/16	1.09	.38	3200	220	6100	420
4K-4 RA	1/4-19	1/4-18	3/4	1.42	.56	3300	230	6200	430
6K-6 RA	3/8-19	3/8-18	7/8	1.49	.56	2600	180	5000	340
8K-8 RA	1/2-14	1/2-14	1 1/8	1.94	.75	2400	160	4600	320
12K-12 RA	3/4-14	3/4-14	1 5/16	2.00	.75	2300	160	4300	300
16K-16 RA	1-11	1-11 1/2	1 5/8	2.28	.94	2200	150	4100	280

Used to connect a male BSPT and a female NPT threaded component.

Female BSPP to Male NPT Adapter

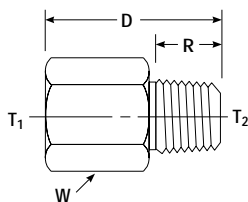
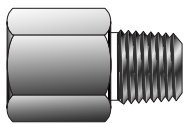

PARKER PART NO.	BSPP THREAD T ₁	NPT THREAD T ₂	W HEX	D	R	Working Pressure			
						Brass		Stainless Steel	
						PSI	BAR	PSI	BAR
2R-2 RA	1/8-28	1/8-27	3/4	1.09	.38	3200	220	6100	420
4R-4 RA	1/4-19	1/4-18	7/8	1.50	.56	3300	230	6200	430
6R-6 RA	3/8-19	3/8-18	1 1/16	1.49	.56	2600	180	5000	340
8R-8 RA	1/2-14	1/2-14	1 1/8	1.88	.75	2400	160	4600	320
12R-12 RA	3/4-14	3/4-14	1 5/16	2.00	.75	2300	160	4300	300
16R-16 RA	1-11	1-11 1/2	1 5/8	2.28	.94	2200	150	4100	280

Used to connect a male BSPP and a female NPT threaded component.

Dimensions for reference only, subject to change.

ISO Conversion Pipe Fittings

BSP Taper Male Hex Pipe Plug

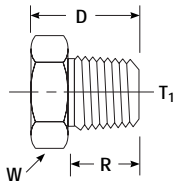
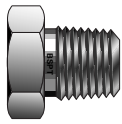

PARKER PART NO.	BSPT THREAD T ₁	W HEX	D	R	Working Pressure			
					Brass		Stainless Steel	
					PSI	BAR	PSI	BAR
2K PH	1/8-28	7/16	.59	.38	3200	220	6100	420
4K PH	1/4-19	5/8	.81	.56	3300	230	6200	430
6K PH	3/8-19	3/4	.81	.56	2600	180	5000	340
8K PH	1/2-14	7/8	1.06	.75	2400	160	3600	320
12K PH	3/4-14	1 1/8	1.13	.75	2300	160	4300	300
16K PH	1-11	1 3/8	1.31	.94	2200	150	4100	280

BSPP Parallel Male Hex Pipe Plug

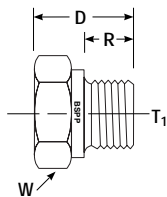

PARKER PART NO.	BSPT THREAD T ₁	W HEX	D	R	Working Pressure			
					Brass		Stainless Steel	
					PSI	BAR	PSI	BAR
2R PH	1/8-28	9/16	.55	.28	5000	340	9100	630
4R PH	1/4-19	3/4	.78	.44	4000	280	7500	520
6R PH	3/8-19	7/8	.78	.44	3900	270	7200	500
8R PH	1/2-14	1-1/16	.99	.56	3800	260	6600	460
12R PH	3/4-14	1-5/16	1.13	.63	3600	250	6400	440
16R PH	1-11	1-5/8	1.21	.72	2600	180	4600	320

Note: Bonded seal page 26 must be used on BSPP end shown.
Please note the pressure ratings are based on taper threaded ends. The pressure rating for the BSPP ends are dependent on the type of sealing washer used.

Dimensions for reference only, subject to change.

ISO Threaded to Fractional Tube Connectors

BSP Taper Male Connector

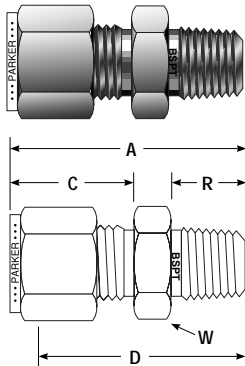

TUBE O. D. INCH	BSP TR. THREAD	PARKER CPI™ PART NUMBER	PARKER A-LOK® PART NUMBER	A INCH	C INCH	D INCH	R INCH	W HEX
1/8	1/8-28	2-2K FBZ	2MSC2K	1.20	.60	.94	.38	7/16
1/8	1/4-19	2-4K FBZ	2MSC4K	1.40	.60	1.14	.56	9/16
1/4	1/8-28	4-2K FBZ	4MSC2K	1.30	.70	1.00	.38	1/2
1/4	1/4-19	4-4K FBZ	4MSC4K	1.50	.70	1.20	.56	9/16
1/4	3/8-19	4-6K FBZ	4MSC6K	1.52	.70	1.22	.56	11/16
1/4	1/2-14	4-8K FBZ	4MSC8K	1.76	.70	1.44	.75	7/8
5/16	1/8-28	5-2K FBZ	5MSC2K	1.34	.73	1.05	.38	9/16
5/16	1/4-19	5-4K FBZ	5MSC4K	1.53	.73	1.23	.56	9/16
3/8	1/8-28	6-2K FBZ	6MSC2K	1.39	.76	1.09	.38	5/8
3/8	1/4-19	6-4K FBZ	6MSC4K	1.59	.76	1.28	.56	5/8
3/8	3/8-19	6-6K FBZ	6MSC6K	1.59	.76	1.28	.56	11/16
3/8	1/2-14	6-8K FBZ	6MSC8K	1.82	.76	1.53	.75	7/8
1/2	1/4-19	8-4K FBZ	8MSC4K	1.75	.87	1.31	.56	13/16
1/2	3/8-19	8-6K FBZ	8MSC6K	1.75	.87	1.31	.56	13/16
1/2	1/2-14	8-8K FBZ	8MSC8K	1.93	.87	1.53	.75	7/8

Connects fractional tube to female ISO taper thread.

BSPP Male Connector

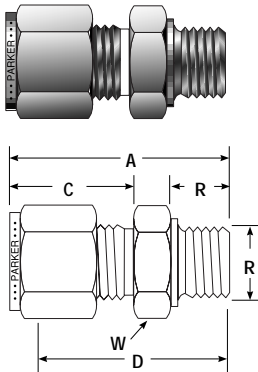

TUBE O. D. INCH	BSP THREAD	PARKER CPI™ PART NUMBER	PARKER A-LOK® PART NUMBER	A INCH	C INCH	D INCH	R INCH	W HEX
1/8	1/8-28	2-2R FBZ	2MSC2R	1.18	.60	0.92	.28	9/16
1/8	1/4-19	2-4R FBZ	2MSC4R	1.38	.60	1.13	.44	3/4
1/8	3/8-19	2-6R FBZ	2MSC6R	1.43	.60	1.17	.44	7/8
1/4	1/8-28	4-2R FBZ	4MSC2R	1.28	.70	0.98	.28	9/16
1/4	1/4-19	4-4R FBZ	4MSC4R	1.49	.70	1.19	.44	3/4
1/4	3/8-19	4-6R FBZ	4MSC6R	1.55	.70	1.25	.44	7/8
1/4	1/2-14	4-8R FBZ	4MSC8R	1.77	.70	1.47	.56	1 1/16
3/8	1/8-28	6-2R FBZ	6MSC2R	1.37	.76	1.06	.28	5/8
3/8	1/4-19	6-4R FBZ	6MSC4R	1.57	.76	1.25	.44	3/4
3/8	3/8-19	6-6R FBZ	6MSC6R	1.59	.76	1.30	.44	7/8
3/8	1/2-14	6-8R FBZ	6MSC8R	1.84	.76	1.53	.56	1 1/16
1/2	1/4-19	8-4R FBZ	8MSC4R	1.71	.87	1.28	.44	13/16
1/2	3/8-19	8-6R FBZ	8MSC6R	1.74	.87	1.30	.44	7/8
1/2	1/2-14	8-8R FBZ	8MSC8R	1.96	.87	1.53	.56	1 1/16
3/4	1/2-14	12-8R FBZ	12MSC8R	1.93	.87	1.53	.56	1 1/16
3/4	3/4-19	12-12R FBZ	12MSC12R	2.10	.87	1.69	.63	1 3/8
1	1/2-14	16-8R FBZ	16MSC8R	2.21	1.05	1.72	.56	1 3/8
1	1-11	16-16R FBZ	16MSC16R	2.37	1.05	1.88	.72	1 5/8

Connects fractional tube to female ISO parallel thread.
NOTE: Bonded Seal, page 26, must be used with BSPP end shown.

BSP Taper Female Connector

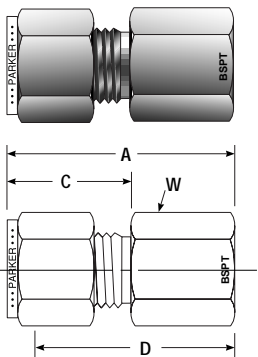

TUBE O. D. INCH	BSPT THREAD	PARKER CPI™ PART NUMBER	PARKER A-LOK® PART NUMBER	A INCH	C INCH	D INCH	W HEX
1/4	1/8-28	4-2K GBZ	4FSC2K	1.23	.70	.94	9/16
1/4	1/4-19	4-4K GBZ	4FSC4K	1.42	.70	1.13	3/4
1/4	3/8-19	4-6K GBZ	4FSC6K	1.48	.70	1.19	7/8
1/4	1/2-14	4-8K GBZ	4FSC8K	1.67	.70	1.38	1 1/16
3/8	1/4-19	6-4K GBZ	6FSC4K	1.48	.76	1.19	3/4
3/8	3/8-19	6-6K GBZ	6FSC6K	1.54	.76	1.25	7/8
3/8	1/2-14	6-8K GBZ	6FSC8K	1.73	.76	1.44	1 1/16
1/2	1/4-19	8-4K GBZ	8FSC4K	1.59	.87	1.19	13/16
1/2	3/8-19	8-6K GBZ	8FSC6K	1.65	.87	1.25	7/8
1/2	1/2-14	8-8K GBZ	8FSC8K	1.84	.87	1.44	1 1/16

Connects fractional tube to male ISO taper thread.

Dimensions for reference only, subject to change.

ISO Threaded to Fractional Tube Connectors

BSPP Female Gauge Connector

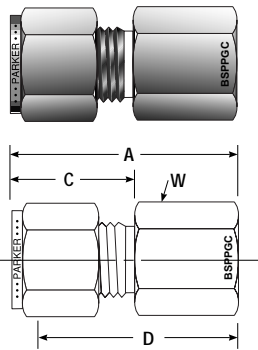

TUBE O. D. INCH	BSPP THREAD	PARKER CPI™ PART NUMBER	PARKER A-LOK® PART NUMBER	A INCH	C INCH	D INCH	W HEX
1/4	1/4-19	4-4GC GBZ	4FSC4GC	1.48	.70	1.19	3/4
1/4	3/8-19	4-6GC GBZ	4FSC6GC	1.48	.70	1.19	15/16
1/4	1/2-14	4-8GC GBZ	4FSC8GC	1.72	.70	1.42	1 1/16
5/16	1/4-19	5-4GC GBZ	5FSC4GC	1.51	.73	1.22	3/4
5/16	1/2-14	5-8GC GBZ	5FSC8GC	1.61	.73	1.32	1 1/16
3/8	1/4-19	6-4GC GBZ	6FSC4GC	1.54	.76	1.25	3/4
3/8	3/8-19	6-6GC GBZ	6FSC6GC	1.53	.76	1.23	15/16
3/8	1/2-14	6-8GC GBZ	6FSC8GC	1.65	.76	1.36	1 1/16
1/2	3/8-19	8-6GC GBZ	8FSC6GC	1.75	.87	1.35	15/16
1/2	1/2-14	8-8GC GBZ	8FSC8GC	1.90	.87	1.50	1 1/16

Connects fractional tube to male ISO parallel (gauge).

NOTE: Copper Washer, page 26, for female thread sealing, must be used on BSPP female end shown.

BSP Taper Male Elbow

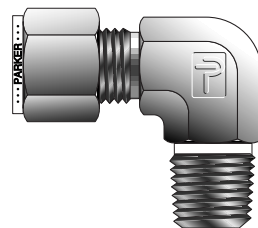

TUBE O. D. INCH	BSPT THREAD	PARKER CPI™ PART NUMBER	PARKER A-LOK® PART NUMBER	C INCH	H INCH	L INCH	R INCH	W HEX
1/4	1/8-28	4-2K CBZ	4MSEL2K	1.06	.74	.77	.38	1/2
1/4	1/4-19	4-4K CBZ	4MSEL4K	1.08	1.00	.78	.56	9/16
1/4	3/8-19	4-6K CBZ	4MSEL6K	1.17	1.13	.88	.56	3/4
1/4	1/2-14	4-8K CBZ	4MSEL8K	1.26	1.31	.97	.75	7/8
5/16	1/4-19	5-4K CBZ	5MSEL4K	1.11	1.00	.81	.56	5/8
3/8	1/8-28	6-2K CBZ	6MSEL2K	1.20	.82	.91	.38	5/8
3/8	1/4-19	6-4K CBZ	6MSEL4K	1.20	1.01	.91	.56	5/8
3/8	3/8-19	6-6K CBZ	6MSEL6K	1.26	1.13	.97	.56	3/4
1/2	3/8-19	8-6K CBZ	8MSEL6K	1.42	1.15	1.02	.56	13/16
1/2	1/2-14	8-8K CBZ	8MSEL8K	1.42	1.30	1.02	.75	7/8

Connects fractional tube to female ISO taper thread.

Dimensions for reference only, subject to change.

ISO Threaded to Fractional Tube Connectors

BSPP Male Elbow (Positionable)

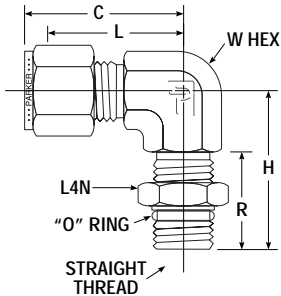
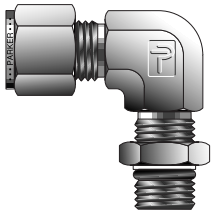

TUBE O. D. INCH	BSPP THREAD	PARKER CPI™ PART NUMBER	PARKER A-LOK® PART NUMBER	C INCH	H INCH	L INCH	R INCH	W HEX
1/4	1/8-28	4-2R CBZ	4MSEL2R	1.06	1.04	.77	.63	9/16
1/4	1/4-19	4-4R CBZ	4MSEL4R	1.14	1.27	.85	.79	9/16
3/8	1/4-19	6-4R CBZ	6MSEL4R	1.14	1.27	.85	.79	9/16
3/8	3/8-19	6-6R CBZ	6MSEL6R	1.50	1.46	1.02	.79	3/4
1/2	1/4-19	8-4R CBZ	8MSEL4R	1.50	1.38	1.10	.79	7/8
1/2	3/8-19	8-6R CBZ	8MSEL6R	1.50	1.46	1.10	.79	7/8
1/2	1/2-14	8-8R CBZ	8MSEL8R	1.50	1.71	1.10	1.03	7/8
5/8	1/2-14	10-8R CBZ	10MSEL8R	1.50	1.81	1.10	1.03	1 1/16
3/4	1/2-14	12-8R CBZ	12MSEL8R	1.57	1.81	1.17	1.03	1 1/16
3/4	3/4-14	12-12R CBZ	12MSEL12R	1.57	1.92	1.17	1.03	1 1/16
1	3/4-14	16-12R CBZ	16MSEL12R	1.94	2.11	1.45	1.03	1 5/16
1	1-11	16-16R CBZ	16MSEL16R	1.94	2.11	1.45	1.20	1 5/16

Connects fractional tube to female ISO parallel thread.

BSPP Male Run Tee (Positionable)

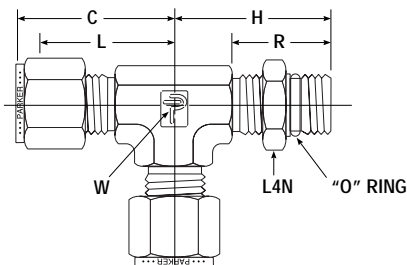
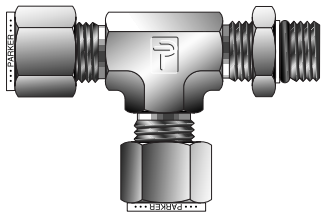

TUBE O. D. INCH	BSPP THREAD	PARKER CPI™ PART NUMBER	PARKER A-LOK® PART NUMBER	C INCH	H INCH	L INCH	R INCH	W HEX
1/4	1/8-28	4-2R-4 RBZ	4MRT2R	1.06	1.04	.77	.63	9/16
1/4	1/4-19	4-4R-4 RBZ	4MRT4R	1.14	1.27	.85	.79	9/16
3/8	1/4-19	6-4R-6 RBZ	6MRT6R	1.20	1.27	.91	.79	9/16
1/2	3/8-19	8-6R-8 RBZ	8MRT8R	1.50	1.46	1.10	.79	7/8
1/2	1/2-14	8-8R-8 RBZ	8MRT8R	1.50	1.71	1.10	1.03	7/8
5/8	1/2-14	10-8R-10 RBZ	10MRT8R	1.50	1.81	1.10	1.03	1 1/16
3/4	1/2-14	12-8R-12 RBZ	12MRT8R	1.57	1.81	1.17	1.03	1 1/16
3/4	3/4-14	12-12R-12 RBZ	12MRT12R	1.57	1.92	1.17	1.03	1 1/16
1	1-11	16-16R-16 RBZ	16MRT16R	1.94	2.11	1.45	1.20	1 5/16

Connects fractional tube to female ISO parallel thread.

Dimensions for reference only, subject to change.

ISO Threaded to Fractional Tube Connectors

BSPP Male Branch Tee (Positionable)

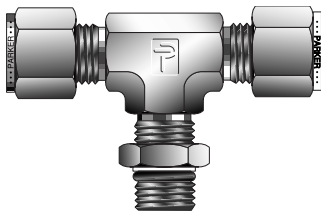

TUBE O. D. INCH	BSPP THREAD	PARKER CPI™ PART NUMBER	PARKER A-LOK® PART NUMBER	C INCH	H INCH	L INCH	R INCH	W HEX
1/4	1/8-28	4-4-2R SBZ	4MBT2R	1.06	1.04	.77	.63	9/16
1/4	1/4-19	4-4-4R SBZ	4MBT4R	1.14	1.27	.85	.79	9/16
3/8	1/4-19	6-6-4R SBZ	6MBT4R	1.14	1.27	.85	.79	9/16
1/2	3/8-19	8-8-6R SBZ	8MBT6R	1.50	1.46	1.10	.79	7/8
1/2	1/2-14	8-8-8R SBZ	8MBT8R	1.50	1.71	1.10	1.03	7/8
5/8	1/2-14	10-10-8R SBZ	10MBT8R	1.50	1.81	1.10	1.03	1 1/16
3/4	1/2-14	12-12-8R SBZ	12MBT8R	1.57	1.81	1.17	1.03	1 1/16
3/4	3/4-14	12-12-12R SBZ	12MBT12R	1.57	1.92	1.17	1.03	1 1/16
1	1-11	16-16-16R SBZ	16MBT16R	1.94	2.11	1.45	1.20	1 5/16

Connects fractional tube to female ISO parallel thread.

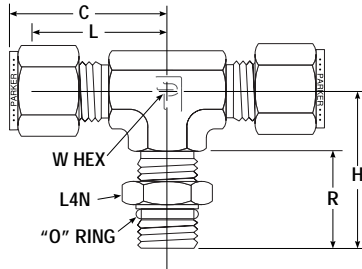

BSP Taper Male Adapter

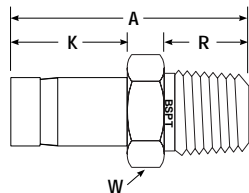
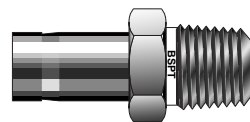

TUBE O. D. INCH	BSPT THREAD	PARKER CPI™ PART NUMBER	PARKER A-LOK® PART NUMBER	CPI™		A-LOK®		R INCH	W HEX	MIN. BORE INCH
				A INCH	K INCH	A INCH	K INCH			
1/8	1/8-28	2-2K T2HF	2MA2K	1.16	0.54	1.16	.54	.38	7/16	.078
1/8	1/4-19	2-4K T2HF	2MA4K	1.39	0.54	1.39	.54	.56	9/16	.281
1/4	1/8-28	4-2K T2HF	4MA2K	1.27	0.64	1.25	.63	.38	7/16	.156
1/4	1/4-19	4-4K T2HF	4MA4K	1.49	0.64	1.46	.63	.56	9/16	.078
5/16	1/8-28	5-2K T2HF	5MA2K	1.32	0.68	1.28	.66	.38	7/16	.219
5/16	1/4-19	5-4K T2HF	5MA4K	1.53	0.68	1.49	.66	.56	9/16	.219
3/8	1/4-19	6-4K T2HF	6MA4K	1.57	0.72	1.53	.69	.56	9/16	.281
3/8	3/8-19	6-6K T2HF	6MA6K	1.61	0.72	1.56	.69	.56	11/16	.281
3/8	1/2-14	6-8K T2HF	6MA8K	1.82	0.72	1.78	.69	.75	7/8	.281
1/2	1/4-19	8-4K T2HF	8MA4K	1.84	0.98	1.75	.91	.75	9/16	.281
1/2	3/8-19	8-6K T2HF	8MA6K	1.87	0.98	1.78	.91	.56	11/16	.375
1/2	1/2-14	8-8K T2HF	8MA8K	2.09	0.98	2.00	.91	.75	7/8	.375
5/8	3/8-19	10-6K T2HF	10MA6K	1.91	1.03	1.84	.97	.56	11/16	.469
5/8	1/2-14	10-8K T2HF	10MA8K	2.14	1.03	2.06	.97	.75	7/8	.469
3/4	3/4-14	12-12K T2HF	12MA12K	2.14	1.03	2.06	.97	.75	1 1/16	.594
1	1-11	16-16K T2HF	16MA16K	2.68	1.30	2.60	1.22	.94	1 3/8	.813

Connects fractional tube to female ISO taper thread.
Generic, annealed tube stub for effective ferrule sealing.

Dimensions for reference only, subject to change.

ISO Threaded to Fractional Tube Connectors

BSPP Male Adapter

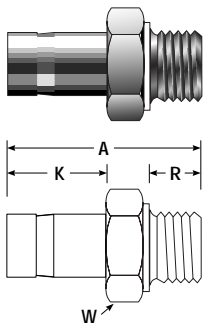

TUBE O.D. INCH	BSPP THREAD	PARKER CPI™ PART NUMBER	PARKER A-LOK® PART NUMBER	CPI™		A-LOK®		R INCH	W HEX	MIN. BORE INCH
				A INCH	K INCH	A INCH	K INCH			
1/8	1/8-28	2-2R T2HF	2MA2R	1.16	.54	1.16	.54	.28	9/16	.078
1/8	1/4-19	2-4R T2HF	2MA4R	1.37	.54	1.37	.54	.44	3/4	.078
1/4	1/8-28	4-2R T2HF	4MA2R	1.26	.64	1.31	.63	.28	9/16	.156
1/4	1/4-19	4-4R T2HF	4MA4R	1.48	.64	1.50	.63	.44	3/4	.156
3/8	1/4-19	6-4R T2HF	6MA4R	1.56	.72	1.57	.69	.44	3/4	.281
3/8	3/8-19	6-6R T2HF	6MA6R	1.59	.72	1.60	.69	.44	7/8	.281
1/2	1/4-19	8-4R T2HF	8MA4R	1.81	.98	1.79	.91	.44	3/4	.375
1/2	3/8-19	8-6R T2HF	8MA6R	1.85	.98	1.82	.91	.44	7/8	.375
1/2	1/2-14	8-8R T2HF	8MA8R	2.10	.98	1.94	.91	.44	1-1/8	.375
3/4	3/4-14	12-12R T2HF	12MA12R	2.22	1.03	2.16	.97	.63	1-3/8	.594
1	1-11	16-16R T2HF	16MA16R	2.67	1.30	2.54	1.22	.72	1-3/4	.813

Connects fractional tube end to female ISO parallel thread.
 NOTE: Bonded Seal, page 21 must be used on BSPP end shown.
 Generic, annealed tube stub for effective sealing.

BSP Taper Female Adapter

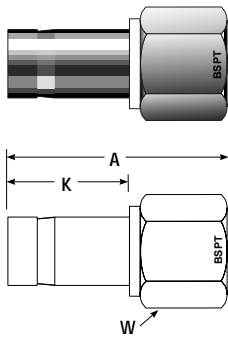

TUBE O.D. INCH	BSPT THREAD	PARKER CPI™ PART NUMBER	PARKER A-LOK® PART NUMBER	CPI™		A-LOK®		W HEX	MIN. BORE INCH
				A INCH	K INCH	A INCH	K INCH		
1/4	1/8-28	4-2K T2HG	4FA2K	1.31	.64	1.30	.63	9/16	.156
1/4	1/4-19	4-4K T2HG	4FA4K	1.48	.64	1.45	.63	3/4	.156
3/8	1/4-19	6-4K T2HG	6FA4K	1.56	.72	1.50	.69	3/4	.281
3/8	3/8-19	6-6K T2HG	6FA6K	1.63	.72	1.59	.69	7/8	.281
1/2	1/4-19	8-4K T2HG	8FA4K	1.83	.98	1.71	.91	3/4	.375
1/2	3/8-19	8-6K T2HG	8FA6K	1.89	.98	1.80	.91	7/8	.375
1/2	1/2-14	8-8K T2HG	8FA8K	2.14	.98	2.05	.91	1-1/16	.375

Connects fractional tube end to male ISO taper thread.
 NOTE: Tube stub is pre-grooved as standard. Generic (non-grooved) can be ordered through Quick Response.

BSPP Female Adapter

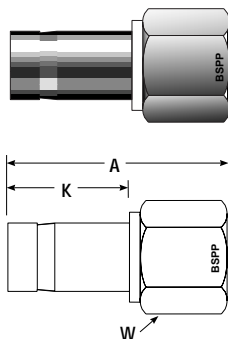

TUBE O.D. INCH	BSPP THREAD	PARKER CPI™ PART NUMBER	PARKER A-LOK® PART NUMBER	CPI™		A-LOK®		W HEX	MIN. BORE INCH
				A INCH	K INCH	A INCH	K INCH		
1/8	1/8-28	2-2R T2HG	2FA2R	1.21	.54	1.21	.54	9/16	.078
1/4	1/8-28	4-2R T2HG	4FA2R	1.31	.64	1.25	.63	9/16	.156
1/4	1/4-19	4-4R T2HG	4FA4R	1.48	.64	1.50	.63	3/4	.156
3/8	1/4-19	6-4R T2HG	6FA4R	1.56	.72	1.55	.69	3/4	.281
3/8	3/8-19	6-6R T2HG	6FA6R	1.63	.72	1.57	.69	7/8	.281
1/2	3/8-19	8-6R T2HG	8FA6R	1.89	.98	1.78	.91	7/8	.375
1/2	1/2-14	8-8R T2HG	8FA8R	2.14	.98	1.95	.91	1-1/16	.375

Connects fractional tube end to male ISO parallel thread.
 NOTE: Tube stub is pre-grooved as standard. Generic (non-grooved) can be ordered through Quick Response.

Dimensions for reference only, subject to change.

ISO Threaded to Fractional Tube Connectors

BSPP Female Gauge Adapter

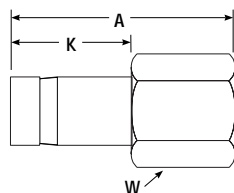
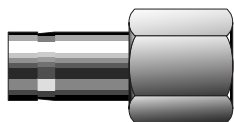

TUBE O.D. INCH	BSPP THREAD	PARKER CPI™ PART NUMBER	PARKER A-LOK® PART NUMBER	CPI™		A-LOK®		W HEX	MIN. BORE INCH
				A INCH	K INCH	A INCH	K INCH		
1/4	1/4-19	4-4GC T2HG	4FA4GC	1.48	.64	1.34	.63	3/4	.156
3/8	3/8-19	6-6GC T2HG	6FA6GC	1.63	.72	1.55	.69	15/16	.281
1/2	1/2-14	8-8GC T2HG	8FA8GC	2.14	.98	1.92	.91	1 1/16	.375

Connects fractional tube end to male ISO parallel thread (gauge).

NOTE: Copper Washer, page 26, for female thread sealing, must be used on BSPP female end shown.

NOTE: Tube stub is pre-grooved as standard. Generic (non-grooved) can be ordered through Quick Response.

Sealing Washers

Bonded Seals

Consists of an outer stainless steel ring with a bonded Viton® inner ring used to seal a male ISO parallel thread.

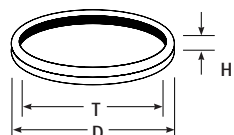

PART NO.	"T" BSPP THREAD	D	H	PRESSURE RATINGS FOR SEALING WASHERS		
				THREAD SIZE	PSI	BAR
M30201-SS	1/8	.63	.08	1/8	5300	370
M30202-SS	1/4	.81	.08	1/4	5500	380
M30203-SS	3/8	.94	.08	3/8	4400	300
M30204-SS	1/2	1.12	.10	1/2	4000	280
M30206-SS	3/4	1.38	.10	3/4	3700	260
M30208-SS	1	1.69	.10	1	2800	190

These seals are also available in steel with a Nitrile inner ring.

Simply replace Suffix SS with S

Copper Washers

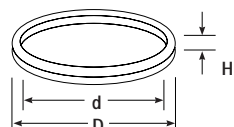

For BSPP male thread sealing

PART NO.	THREAD	D	d	H
M28329	1/8	.71	.39	.09
M28330	1/4	.87	.55	.09
M28331	3/8	.94	.67	.09
M28332	1/2	1.18	.87	.10
M28334	3/4	1.38	1.06	.09
M28336	1	1.65	1.34	.09

For BSPP female thread sealing

PART NO.	THREAD	D	d	H
M25179	1/8	0.322	0.218	0.062
M25180	1/4	0.436	0.312	0.062
M25181	3/8	0.574	0.437	0.062
M25182	1/2	0.719	0.562	0.062
M25184	3/4	0.935	0.812	0.062
M25186	1	1.178	1	0.093

Used to provide a seal with male or female parallel ISO threads.

Please note the pressure ratings are based on taper threaded ends. The pressure rating for the BSPP ends are dependent on the type of sealing washer used.

Dimensions for reference only, subject to change.

Thread and Tube End Size Chart (U.S.A.)

NPT Thread

Straight Thread

Tubing O.D. Size

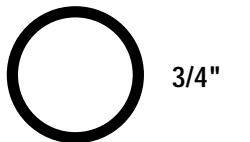
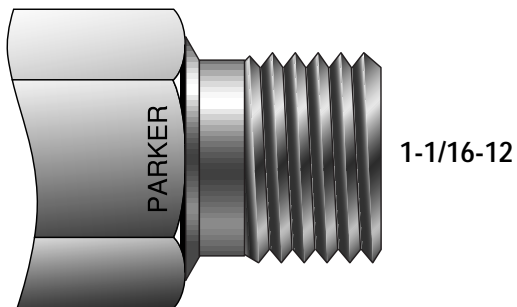
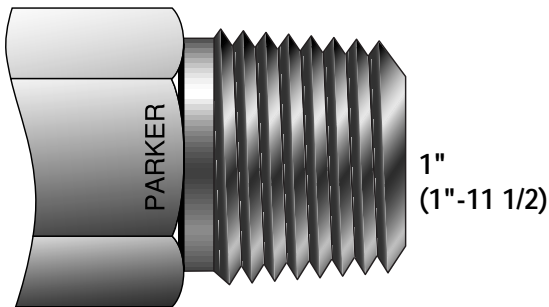
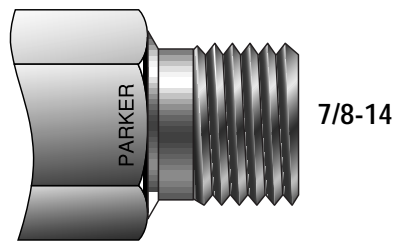
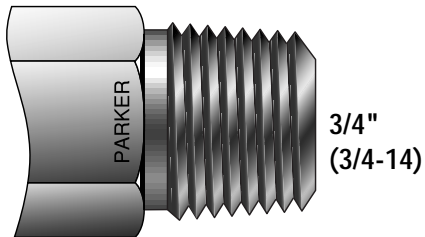
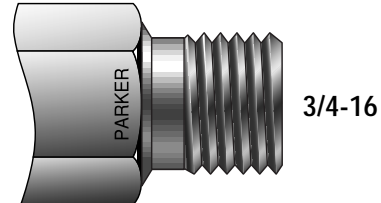
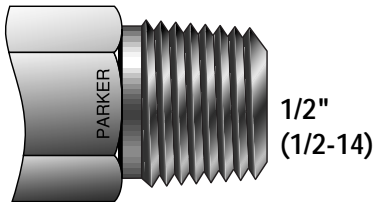
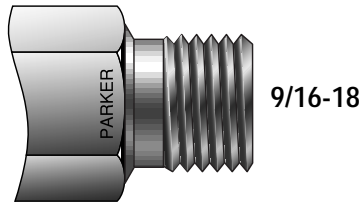
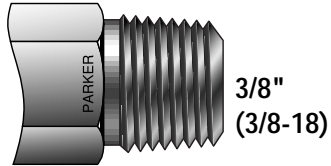
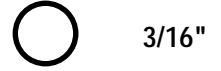
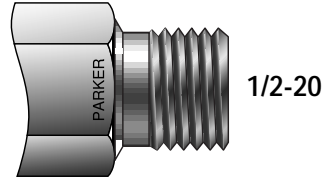
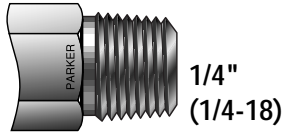
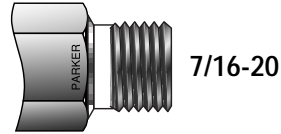
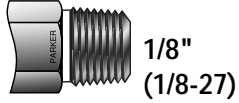
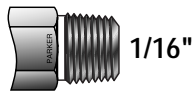

American Standard Pipe Thread (NPT)

American Standard Unified Thread (Straight)

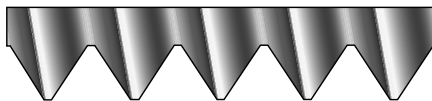
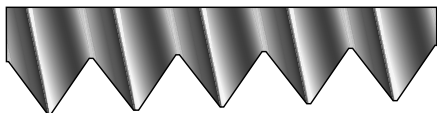

60° thread angle • Pitch measured in inches
 • Truncation of root and crest are flat
 • Taper angle 1°47'

60° thread angle • Pitch measured in inches
 • Truncation of root and crest are flat
 • Diameter measured in inches

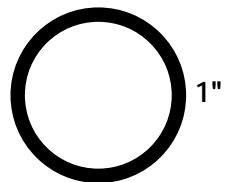

Pipe and Tube End Size Chart (U.S.A.)

NPT Thread

Tubing O.D. Size

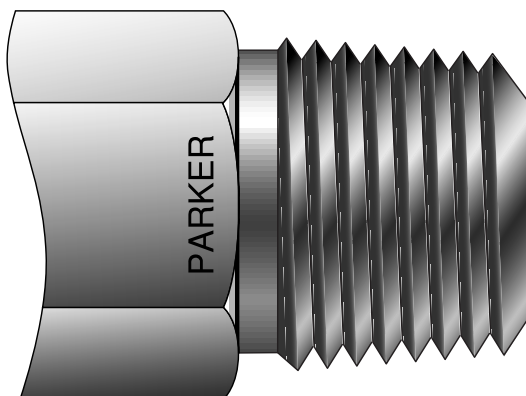

1-1/4"

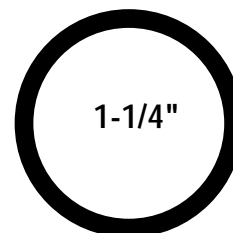

1-1/4"

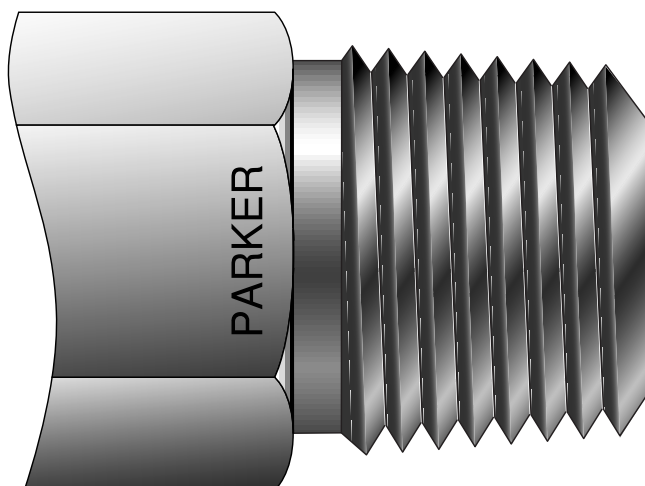

1-1/2"

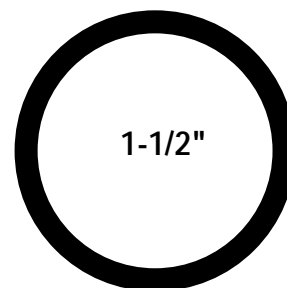

1-1/2"

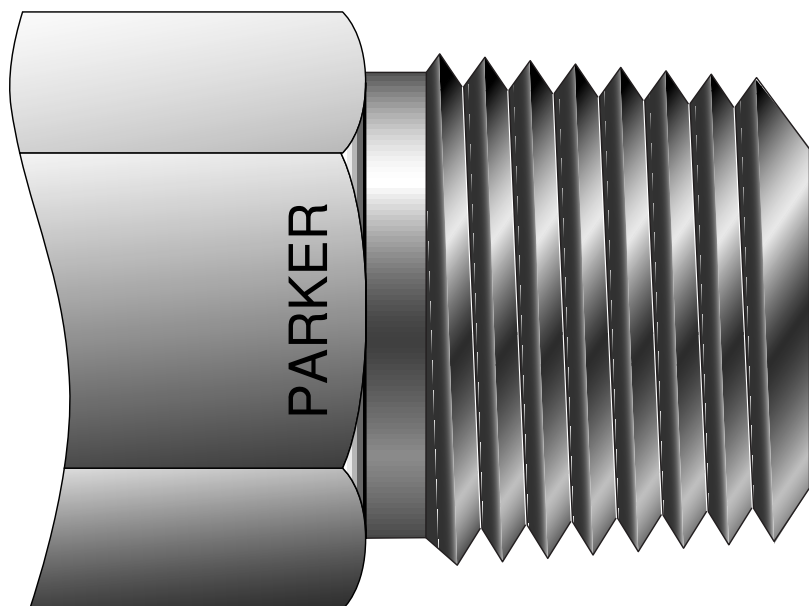

2"

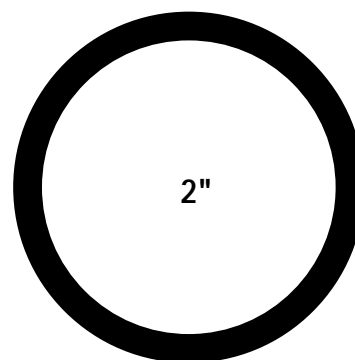

2"

Thread and Tube End Size Chart (International)

BSPT Tapered Thread

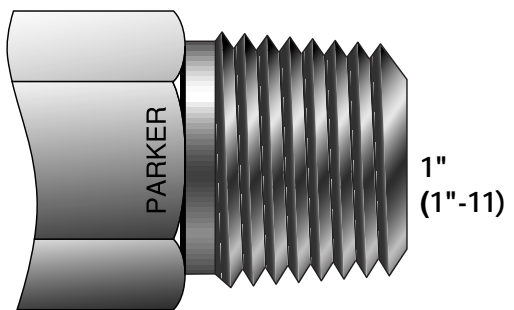
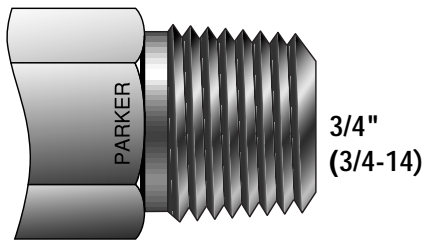
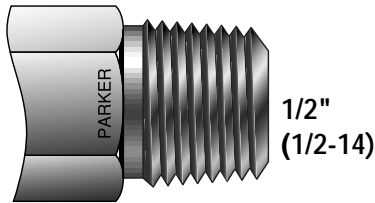
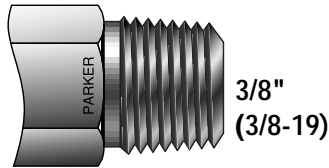
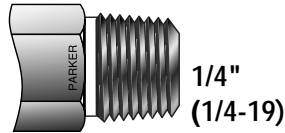
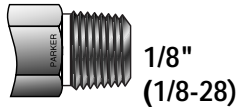

BSPF Parallel Thread

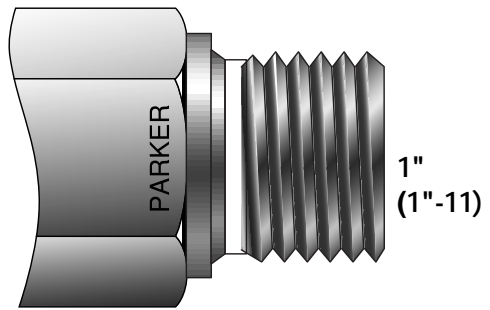
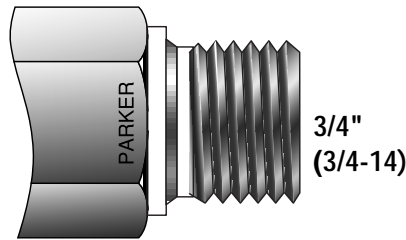
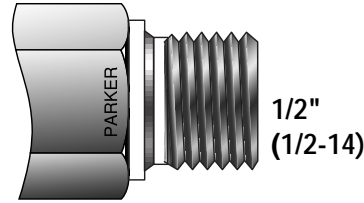
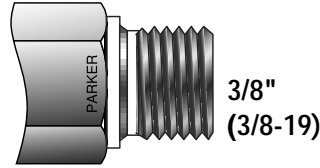
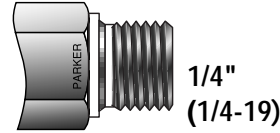
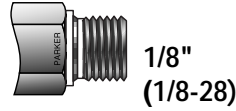

Tubing O.D. Size

- 2mm
- 3mm
- 4mm
- 6mm
- 8mm
- 10mm
- 12mm
- 14mm
- 15mm
- 16mm
- 18mm
- 20mm
- 22mm
- 25mm

International Organization for Standards

(ISO 7/1)

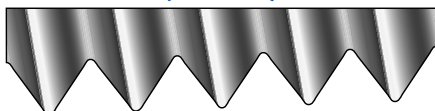

- 55° thread angle • Pitch measured in inches
- Truncation of root and crest are round
- Taper angle 1°47'

(ISO 228/1)

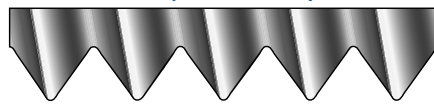

- 55° thread angle • Pitch measured in inches
- Truncation of root and crest are round
- Diameter measured in inches

Heat Code Traceability

Parker Hannifin's Instrumentation Connectors Division offers Heat Code Traceability (HCT) on CPI™, A-LOK®, Instrumentation Pipe, and Weld-Lok fittings.

HCT refers to the fact that a specific part can be traced back to the original mill heat of metal from which it was made. Beginning with the original melt, a package of documents is created which completely describes the metal in physical and chemical terms. The end result is that a number, which is permanently stamped to the part, refers back to the document package.

The HCT number is stamped on the material (bar stock or forging) prior to manufacturing. The concept is useful because it provides a method for complete material accountability for the manufacturer and end customer.

HCT offers these advantages:

- Raw materials for manufacture must meet code requirements. This can be verified through documentation so that the customer is certain that what is ordered is received.
- HCT provides a record of chemical analysis with the raw material. Thus, in areas requiring welding, the correct welding technique is applied.

- HCT relieves the user of Parker instrumentation tube fittings of any doubts. It acts as an assurance for today and for tomorrow.

The material used in Parker Hannifin instrumentation fitting components is 316 or 316L (welded products) stainless steel as specified and referenced in Section III of the ASME Boiler and Pressure Vessel code.

The American Society of Mechanical Engineers (ASME) Boiler and Vessel Code, Section III, latest issue, entitled Rules for Construction of Nuclear Power Plant Components, is the principal document covering this type of fitting in the nuclear field. ANSI Standard B.31.1.0, Power Piping, and ANSI Standard B.31.7, Nuclear Power Piping, are also important documents in the field.

In addition to the documentation of chemical and physical properties, great care is taken throughout the manufacture of Parker's tube fittings to ensure that potential stress corrosion will not be a problem in normal usage of the parts. Manufacturing processes avoid exposure of the parts to mercury or halogens, and control of thermal treatment avoids the condition known as continuous grain boundary carbide precipitation.

For additional information please contact your local authorized Parker Instrumentation distributor or call Parker Instrumentation Connectors Division and ask for Bulletin 4230-B15.

Offer of Sale

The items described in this document and other documents or descriptions provided by Parker Hannifin Corporation, its subsidiaries and its authorized distributors are hereby offered for sale at prices to be established by Parker Hannifin Corporation, its subsidiaries and its authorized distributors. This offer and its acceptance by any customer ("Buyer") shall be governed by all of the following Terms and Conditions. Buyer's order for any such items, when communicated to Parker Hannifin Corporation, its subsidiary or an authorized distributor ("Seller") verbally or in writing, shall constitute acceptance of this offer.

1. Terms and Conditions of Sale: All descriptions, quotations, proposals, offers, acknowledgments, acceptances and sales of Seller's products are subject to and shall be governed exclusively by the terms and conditions stated herein. Buyer's acceptance of any offer to sell is limited to these terms and conditions. Any terms or conditions in addition to, or inconsistent with those stated herein, proposed by Buyer in any acceptance of an offer by Seller, are hereby objected to. No such additional, different or inconsistent terms and conditions shall become part of the contract between Buyer and Seller unless expressly accepted in writing by Seller. Seller's acceptance of any offer to purchase by Buyer is expressly conditional upon Buyer's assent to all the terms and conditions stated herein, including any terms in addition to, or inconsistent with those contained in Buyer's offer. Acceptance of Seller's products shall in all events constitute such assent.

2. Payment: Payment shall be made by Buyer net 30 days from the date of delivery of the items purchased hereunder. Amounts not timely paid shall bear interest at the maximum rate permitted by law for each month or portion thereof that the Buyer is late in making payment. Any claims by Buyer for omissions or shortages in a shipment shall be waived unless Seller receives notice thereof within 30 days after Buyer's receipt of the shipment.

3. Delivery: Unless otherwise provided on the face hereof, delivery shall be made F.O.B. Seller's plant. Regardless of the method of delivery, however, risk of loss shall pass to Buyer upon Seller's delivery to a carrier. Any delivery dates shown are approximate only and Seller shall have no liability for any delays in delivery.

4. Warranty: Seller warrants that items sold hereunder shall be free from defects in material or workmanship. **THIS WARRANTY COMPRISES THE SOLE AND ENTIRE WARRANTY PERTAINING TO ITEMS PROVIDED HEREUNDER. SELLER MAKES NO OTHER WARRANTY, GUARANTEE, OR REPRESENTATION OF ANY KIND WHATSOEVER. ALL OTHER WARRANTIES, INCLUDING BUT NOT LIMITED TO, MERCHANTABILITY AND FITNESS FOR PURPOSE, WHETHER EXPRESS, IMPLIED, OR ARISING BY OPERATION OF LAW, TRADE USAGE, OR COURSE OF DEALING ARE HEREBY DISCLAIMED.**

NOTWITHSTANDING THE FOREGOING, THERE ARE NO WARRANTIES WHATSOEVER ON ITEMS BUILT OR ACQUIRED WHOLLY OR PARTIALLY, TO BUYER'S DESIGNS OR SPECIFICATIONS.

5. Limitation Of Remedy: SELLER'S LIABILITY ARISING FROM OR IN ANY WAY CONNECTED WITH THE ITEMS SOLD OR THIS CONTRACT SHALL BE LIMITED EXCLUSIVELY TO REPAIR OR REPLACEMENT OF THE ITEMS SOLD, AT SELLER'S SOLE OPTION. IN NO EVENT SHALL SELLER BE LIABLE FOR ANY INCIDENTAL, CONSEQUENTIAL OR SPECIAL DAMAGES OF ANY KIND OR NATURE WHATSOEVER, INCLUDING BUT NOT LIMITED TO LOST PROFITS ARISING FROM OR IN ANY WAY CONNECTED WITH THIS AGREEMENT OR ITEMS SOLD HEREUNDER, WHETHER ALLEGED TO ARISE FROM BREACH OF CONTRACT, EXPRESS OR IMPLIED WARRANTY, OR IN TORT, INCLUDING WITHOUT LIMITATION, NEGLIGENCE, FAILURE TO WARN OR STRICT LIABILITY.

6. Changes, Reschedules and Cancellations: Buyer may request to modify the designs or specifications for the items sold hereunder as well as the quantities and delivery dates thereof, or may request to cancel all or part of this order, however, no such requested modification or cancellation shall become part of the contract between Buyer and Seller unless accepted by Seller in a written amendment to this Agreement. Acceptance of any such requested modification or cancellation shall be at Seller's discretion, and shall be upon such terms and conditions as Seller may require.

7. Special Tooling: A tooling charge may be imposed for any special tooling, including without limitation, dies, fixtures, molds and patterns, acquired to manufacture items sold pursuant to this contract. Such special tooling shall be and remain Seller's property notwithstanding payment of any charges by Buyer. In no event will Buyer acquire any interest in apparatus belonging to Seller which is utilized in the manufacture of the items sold hereunder, even if such apparatus has been specially converted or adapted for such manufacture and not withstanding any charges paid by Buyer. Unless otherwise agreed, Seller shall have the right to alter, discard or otherwise dispose of any special tooling or other property in its sole discretion at any time.

8. Buyer's Property: Any designs, tools, patterns, materials, drawings, confidential information or equipment furnished by Buyer or any other items which become Buyer's property, may be considered obsolete and may be destroyed by Seller after two (2) consecutive years have elapsed without Buyer placing an order for the items which are manufactured using such property, Seller shall not be responsible for any loss or damage to such property while it is in Seller's possession or control.

9. Taxes: Unless otherwise indicated on the face hereof, all prices and charges are exclusive of excise, sales, use, property, occupational or like taxes which may be imposed by any taxing authority upon the manufacture, sale or delivery of the items sold hereunder. If any such taxes must be paid by Seller or if Seller is liable for the collection of such tax, the amount thereof shall be in addition to the amounts for the items sold. Buyer agrees to pay all such taxes or to reimburse Seller therefore upon receipt of its invoice. If Buyer claims exemption from any sales, use or other tax imposed by any taxing authority, Buyer shall save Seller harmless from and against any such tax, together with any interest or penalties thereon which may be assessed if the items are held to be taxable.

10. Indemnity For Infringement of Intellectual Property Rights: Seller shall have no liability for infringement of any patents, trademarks, copyrights, trade dress, trade secrets or similar rights except as provided in this Part 10. Seller will defend and indemnify Buyer against allegations of infringement of U.S. Patents, U.S. Trademarks, copyrights, trade dress and trade secrets (hereinafter 'Intellectual Property Rights'). Seller will defend at its expense and will pay the cost of any settlement or damages awarded in an action brought against Buyer based on an allegation that an item sold pursuant to this contract infringes the Intellectual Property Rights of a third party. Seller's obligation to defend and indemnify Buyer is contingent on Buyer notifying Seller within ten (10) days after Buyer becomes aware of such allegations of infringement, and Seller having sole control over the defense of any allegations or actions including all negotiations for settlement or compromise. If an item sold hereunder is subject to a claim that it infringes the Intellectual Property Rights of a third party, Seller may, at its sole expense and option, procure for Buyer the right to continue using said item, replace or modify said item so as to make it noninfringing, or offer to accept return of said item and return the purchase price less a reasonable allowance for depreciation. Notwithstanding the foregoing, Seller shall have no liability for claims of infringement based on information provided by Buyer, or directed to items delivered hereunder for which the designs are specified in whole or part by Buyer, or infringements resulting from the modification, combination or use in a system of any item sold hereunder. The foregoing provisions of this Part 10 shall constitute Seller's sole and exclusive liability and Buyer's sole and exclusive remedy for infringement of Intellectual Property Rights.

If a claim is based on information provided by Buyer or if the design for an item delivered hereunder is specified in whole or in part by Buyer, Buyer shall defend and indemnify Seller for all costs, expenses or judgments resulting from any claim that such item infringes any patent, trademark, copyright, trade dress, trade secret or any similar right.

11. Force Majeure: Seller does not assume the risk of and shall not be liable for delay or failure to perform any of Seller's obligations by reason of circumstances beyond the reasonable control of Seller (hereinafter 'Events of Force Majeure'). Events of Force Majeure shall include without limitation, accidents, acts of God, strikes or labor disputes, acts, laws, rules or regulations of any government or government agency, fires, floods, delays or failures in delivery of carriers or suppliers, shortages of materials and any other cause beyond Seller's control.

12. Entire Agreement/Governing Law: The terms and conditions set forth herein, together with any amendments, modifications and any different terms or conditions expressly accepted by Seller in writing, shall constitute the entire Agreement concerning the items sold, and there are no oral or other representations or agreements which pertain thereto. This Agreement shall be governed in all respects by the law of the State of Ohio. No actions arising out of the sale of the items sold hereunder or this Agreement may be brought by either party more than two (2) years after the cause of action accrues.

11/98-P



Parker Hannifin Corporation
 6035 Parkland Blvd.
 Cleveland, Ohio 44124-4141
 Telephone: (216) 896-3000
 Fax: (216) 896-4000
 Web site: www.parker.com

Parker Hannifin Corporation

About Parker Hannifin Corporation

Parker Hannifin is a leading global motion-control company dedicated to delivering premier customer service. A Fortune 500 corporation listed on the New York Stock Exchange (PH), our components and systems comprise over 1,400 product lines that control motion in some 1,000 industrial and aerospace markets. Parker is the only manufacturer to offer its customers a choice of hydraulic, pneumatic, and electromechanical motion-control solutions. Our Company has the largest distribution network in its field, with over 7,500 distributors serving more than 350,000 customers worldwide.

Parker's Charter

To be a leading worldwide manufacturer of components and systems for the builders and users of durable goods. More specifically, we will design, market and manufacture products controlling motion, flow and pressure. We will achieve profitable growth through premier customer service.

Product Information

North American customers seeking product information, the location of a nearby distributor, or repair services will receive prompt attention by calling the Parker Product Information Center at our toll-free number: 1-800-C-PARKER (1-800-272-7537). In the UK, a similar service is available by calling 0500-103-203.

The Aerospace Group is a leader in the development, design, manufacture and servicing of control systems and components for aerospace and related high-technology markets, while achieving growth through premier customer service.



The Climate & Industrial Controls Group designs, manufactures and markets system-control and fluid-handling components and systems to refrigeration, air-conditioning and industrial customers worldwide.

The Fluid Connectors Group designs, manufactures and markets rigid and flexible connectors, and associated products used in pneumatic and fluid systems.

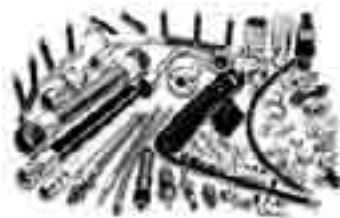

The Seal Group designs, manufactures and distributes industrial and commercial sealing devices and related products by providing superior quality and total customer satisfaction.

The Hydraulics Group designs, produces and markets a full spectrum of hydraulic components and systems to builders and users of industrial and mobile machinery and equipment.



The Filtration Group designs, manufactures and markets quality filtration and clarification products, providing customers with the best value, quality, technical support, and global availability.

The Automation Group is a leading supplier of pneumatic and electromechanical components and systems to automation customers worldwide.



The Instrumentation Group is a global leader in the design, manufacture and distribution of high-quality critical flow components for worldwide process instrumentation, ultra-high-purity, medical and analytical applications.



Parker Hannifin Corporation

Instrumentation Connectors Division
P.O. Box 400004-1504
Huntsville, AL 35815-1504
USA
Phone: (256) 881-2040
Fax: (256) 881-5730
www.parker.com/ICD

Parker Hannifin plc

Instrumentation Products Division
Riverside Road
Pottington Industrial Estate
Barnstaple, Devon EX31 1NP
England
Phone: (44) (1271) 313131
Fax: (44) (1271) 373636
www.parker.com/instrumentation